

Kontinua

Lastre in gres porcellanato 6,5 mm



CASALGRANDE
PADANA
Pave your way

index collections

8 Marmoker

- 18 Statuario Grigio
- 19 Statuario Oro
- 20 Bardiglio Bianco
- 21 Veselye
- 22 Bianco Vietnam
- 23 Olimpo
- 24 Arabesque
- 25 Travertino Titanium
- 26 Pulpis Tortora
- 27 Saint Laurent
- 28 Bardiglio Imperiale
- 29 Grafite
- 30 Nero Creta

44 Pietre di Paragone

- 50 Grigio Aitos
- 51 Grigio Tao
- 52 Pietra del Cardoso

58 Pietre di Sardegna

- 64 Punta Molara
- 65 Caprera
- 66 Porto Rotondo
- 67 Porto Cervo
- 68 Cala Luna
- 69 Tavolara

74 Cemento

- 80 Cassero Bianco
- 81 Cassero Beige
- 82 Cassero Grigio
- 83 Cassero Antracite

93 Tech info

Kontinua

Lastre in gres porcellanato 6,5mm

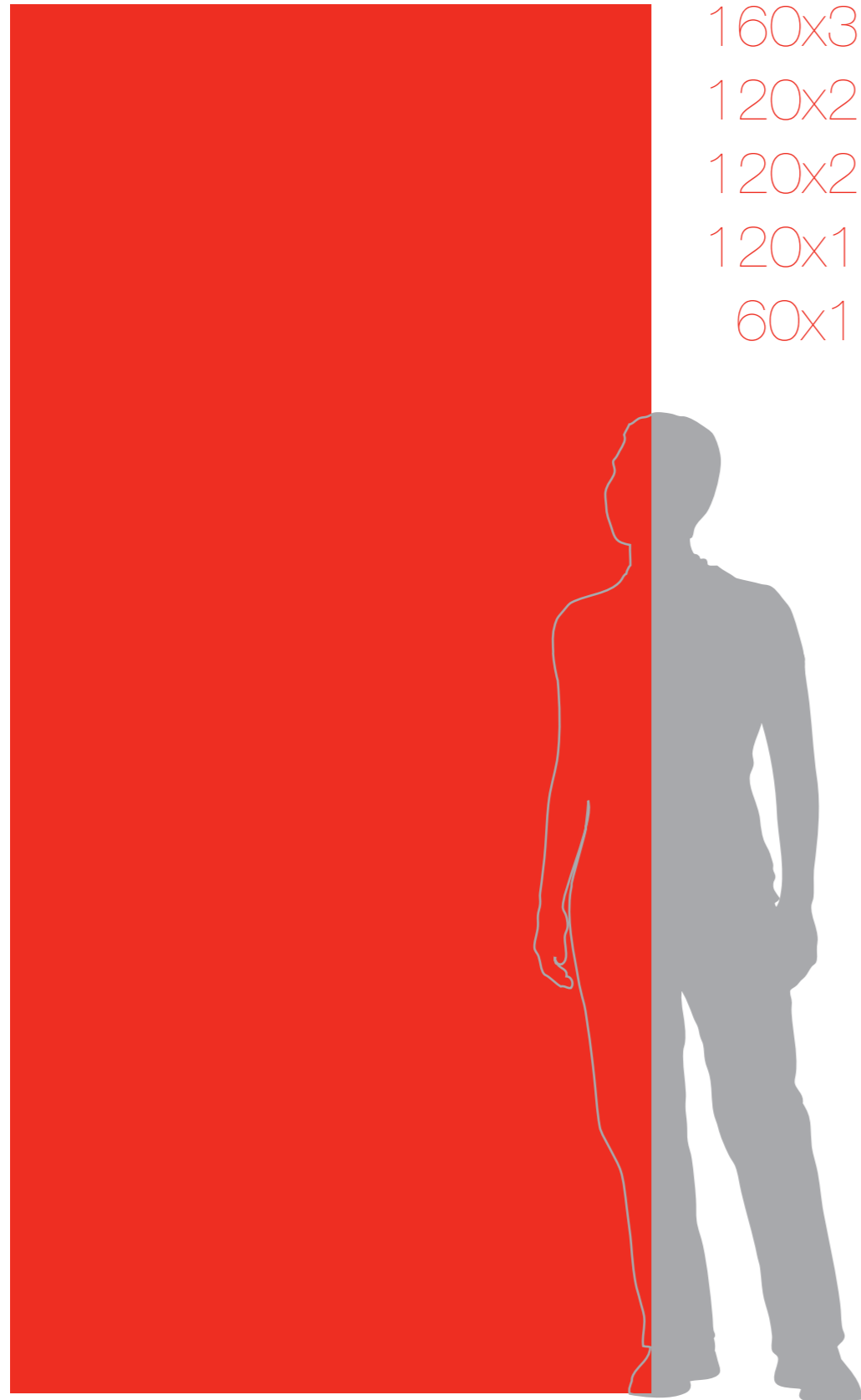

160x320

120x260

120x240

120x120

60x120

Lightweight slabs
and large sizes
to widen your
design horizons.

Légèreté et grandes
dimensions repoussent
les limites de la
conception.

Leichtigkeit und
große Formate zur
Erweiterung der
Planungsmöglichkeiten.

Leggerezza e
grandi dimensioni
per espandere
la progettualità.

Kontinua è il nome che identifica le nuove lastre in gres porcellanato di grande formato a spessore sottile, pensato per sottolineare un'evoluzione produttiva in continuo divenire che arricchirà la trasversalità e l'ampiezza dell'offerta di Casalgrande Padana. A partire da una selezione di prodotti della collezione Marmoker, Pietre di Paragone, Pietre di Sardegna e Cemento, Kontinua estende la gamma con i formati 160x320 cm, 120x260 cm, 120x240 cm, 120x120 cm e 60x120 cm, in 6,5 mm, per soluzioni integrate con i prodotti a spessore tradizionale che rispondono alle rinnovate esigenze del progetto contemporaneo.

Kontinua is the name of Casalgrande Padana's large and thin porcelain stoneware slabs, the latest product in a constantly evolving range designed to expand the possible uses and broad scope of the brand's products. Beginning with a selection of products from the Marmoker, Pietre di Paragone, Pietre di Sardegna and Cemento collections, Kontinua is extending the range with 6.5 mm thick slabs measuring 160x320 cm, 120x260 cm, 120x240 cm, 120x120 cm and 60x120 cm. These can be integrated with the traditional thickness products, helping to meet the extra demands of contemporary design.

Kontinua est désormais synonyme des nouvelles dalles en grès cérame de grand format et de faible épaisseur, traduisant l'évolution incessante de la production, qui enrichira le caractère transversal et l'ampleur de la gamme offerte par Casalgrande Padana. À partir d'une sélection de produits de la collection Marmoker, Pietre di Paragone, Pietre di Sardegna et Cemento, Kontinua élargit la gamme avec les formats 160x320 cm, 120x260 cm, 120x240 cm, 120x120 cm et 60x120 cm, en 6,5 mm, pour obtenir des solutions intégrées avec les produits à épaisseur traditionnelle qui répondent aux nouvelles exigences de conception contemporaine.

Kontinua ist der Name, der die neuen großformatigen Feinsteinzeugplatten mit geringer Stärke bezeichnet, die entwickelt wurden, um eine kontinuierliche Produktweiterentwicklung hervorzuheben, die die Transversalität und Breite des Angebots von Casalgrande Padana bereichern wird. Ausgehend von einer Auswahl an Produkten aus den Kollektionen Marmoker, Pietre di Paragone, Pietre di Sardegna und Cemento, erweitert Kontinua das Sortiment mit den Formaten 160x320 cm, 120x260 cm, 120x240 cm, 120x120 cm und 60x120 cm mit 6,5 mm Stärke, für kombinierte Lösungen mit Produkten traditioneller Stärke, die den neuen Bedürfnissen zeitgenössischer Projekte entsprechen.

Kontinua

Lastre in gres porcellanato 6,5mm



A mix of sizes and thicknesses to make every project unique.

Un mélange de formats et d'épaisseurs pour rendre chaque projet original.

Eine Mischung aus Formaten und Stärken, die jedes Projekt einzigartig macht.

Un mix di formati e spessori per rendere originale ogni progetto.

La modularità dei formati a spessore tradizionale unita a quella delle lastre Kontinua moltiplica le combinazioni creative a disposizione del progettista per soluzioni integrate a pavimento e rivestimento, applicazioni tecniche, facciate ventilate e arredi su misura, in progetti che spaziano dalle grandi aree pubbliche e commerciali fino agli ambienti residenziali. Il grande formato esalta le texture ricercate delle superfici ed è perfettamente abbinabile ai formati in gres porcellanato con spessore 10 mm, garantendo una continuità stilistica ma articolata che si adatta a spazi con destinazioni d'uso differenti, attraverso un coordinamento estetico e funzionale di grande forza espressiva.

The fact that the Kontinua range can be combined with traditional thickness slabs greatly increases the creative pairings available for architects designing integrated flooring and cladding solutions, technical applications, rainscreens and bespoke furnishings, in designs ranging from large public and commercial areas to residential environments. The large size of the slabs brings out the exquisite textures on their surfaces, and they can be used interchangeably with the 10 mm thick porcelain stoneware, guaranteeing stylistic continuity as well as clear definition. They are suitable for spaces with a variety of different uses, providing aesthetic and functional coordination with great expressive potential.

Le caractère modulaire des formats à épaisseur traditionnelle, combiné aux dalles Kontinua, multiplie les possibilités de combinaisons créatives dont dispose le concepteur pour la réalisation de sols, revêtements, applications techniques, façades ventilées, ameublement sur-mesure, dans le cadre de projets allant des grands espaces publics ou commerciaux aux espaces résidentiels. Le grand format met en vedette les textures sophistiquées des surfaces et se combine parfaitement avec les formats en grès cérame avec épaisseur de 10 mm, en garantissant une continuité stylistique, mais bien articulée, qui s'adapte à des espaces destinés à différents usages, au moyen d'une coordination esthétique et fonctionnelle porteuse d'une grande force expressive.

Die Modularität der Formate mit traditioneller Stärke in Verbindung mit derjenigen der Kontinua-Platten vervielfältigt die kreativen Kombinationsmöglichkeiten, die dem Designer für integrale Boden- und Verkleidungslösungen, technische Anwendungen, belüftete Fassaden und maßgeschneiderte Einrichtungen in Projekten zur Verfügung stehen, die von großen öffentlichen und gewerblichen Bereichen bis zu Wohnräumen reichen. Das große Format unterstreicht die ausgesuchten Oberflächentexturen und kann perfekt mit Feinsteinzeugformaten mit 10 mm Stärke kombiniert werden, wobei eine stilistische aber artikulierte Kontinuität gewährleistet ist, die sich durch die ästhetische und funktionelle Koordination mit großer Ausdruckskraft an unterschiedlich genutzte Räume anpasst.

marmoker granitoker



- Statuario Grigio
- Statuario Oro
- Bardiglio Bianco
- Veselye
- Bianco Vietnam
- Olimpo
- Arabesque
- Travertino Titanium
- Pulpis Tortora
- Saint Laurent
- Bardiglio Imperiale
- Grafite
- Nero Creta





















marmoker nero creta



marmoker 90x180

granitoker

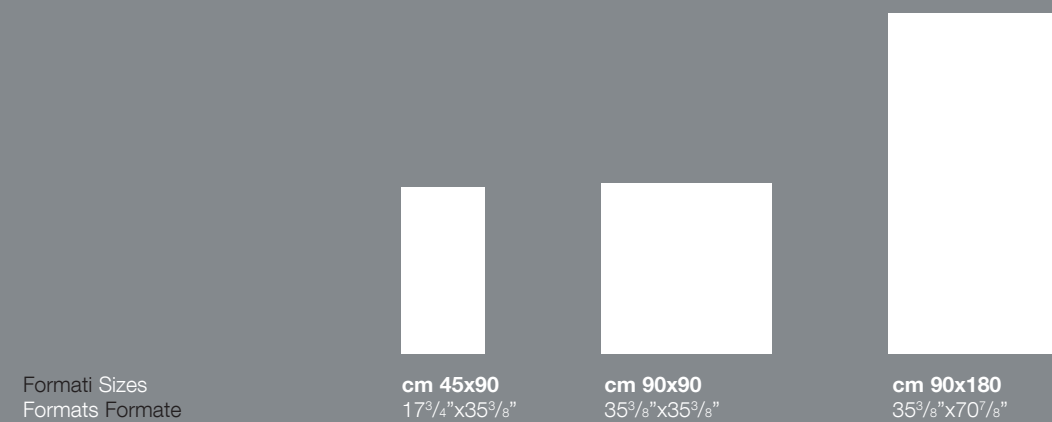

Arabesque	•	•	•
Bianco Vietnam	•	•	•
Breccia Carsica	•	•	•
Breccia Sarda	•	•	•
Fiorito	•	•	•
Grafite	•	•	•
Grigio Billiemi	•	•	•
Jolie	•	•	•
Silvia Oro	•	•	•
Statuario Grigio	•	•	•
Travertino Titanium	•	•	•
Verde Avere	•	•	•
Veselye	•	•	•
Spessori Thicknesses	mm 10	mm 10	mm 10
Epaisseurs Stärke			

- Naturale Matt Naturelle Matt R9
- Lucida

Rettificata in un unico calibro. Single caliber, rectified version. Rectifiés en un unique calibre. Einem einzigen Werkmass maßgeschliffen geliefert.

composizione bookmatch & endmatch

marmoker statuario grigio

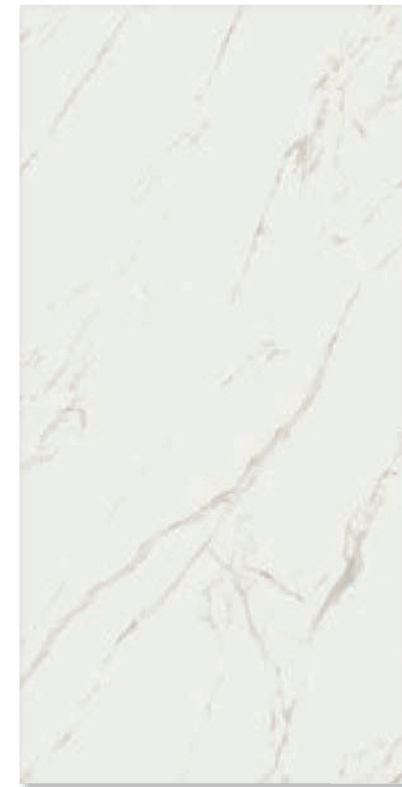

statuario grigio A

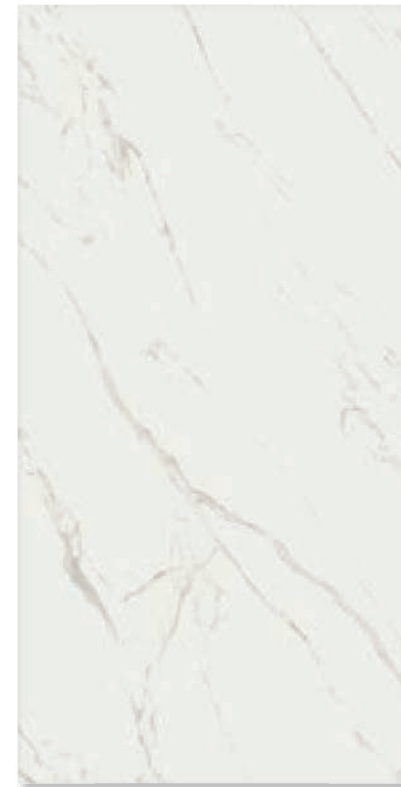

statuario grigio A sp

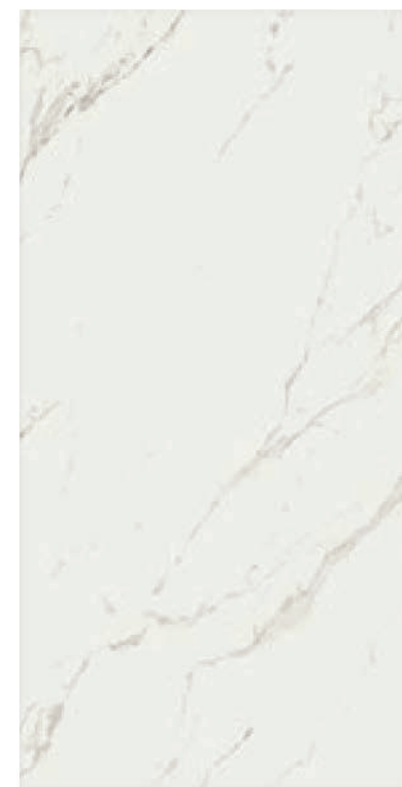

statuario grigio B

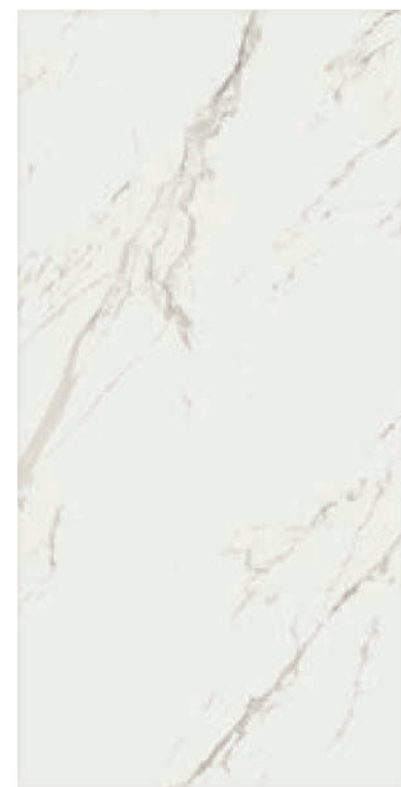

statuario grigio C

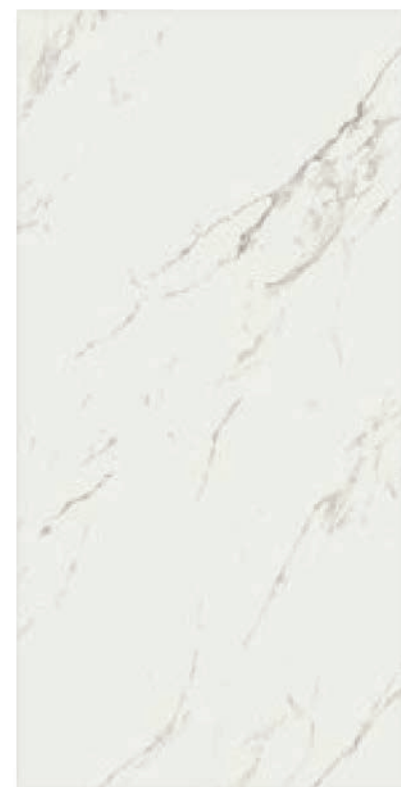

statuario grigio D

marmoker Kontinua

granitoker

Formati Sizes	cm 59x118	cm 118x118
Formats Formate	23 ¹ / ₂ "x46 ¹ / ₂ "	46 ¹ / ₂ "x46 ¹ / ₂ "
Superfici Surfaces	• •	• •
Surfaces Oberflächen		
Spessori Thicknesses	mm 6,5	mm 6,5
Epaisseurs Stärken		mm 10

Formati Sizes	cm 118x236	cm 118x258	cm 160x320*
Formats Formate	46 ¹ / ₂ "x92 ¹ / ₈ "	46 ¹ / ₂ "x101 ¹ / ₈ "	63"x126"
Superfici Surfaces	• •	• •	• •
Surfaces Oberflächen			
Spessori Thicknesses	mm 6,5	mm 6,5	mm 12
Epaisseurs Stärken			

- Naturale Matt Naturelle Matt
- Lucida

* Disponibile nei colori Available in the colours Disponible dans les couleurs Verfügbar in den folgenden Farben:
Statuario Grigio, Statuario Oro, Grafite, Nero Creta

Le lastre Kontinua si abbinano con tutti i colori della collezione Marmoker prodotti anche nei formati in spessore **10 mm**.
The Kontinua slabs match all the Marmoker collection colours, which are also produced in a 10 mm thick sizes. Les dalles Kontinua se combinent avec toutes les couleurs de la collection Marmoker, produites dans des formats d'une épaisseur de **10 mm**. Die Kontinua-Platten lassen sich mit allen Farben der Kollektion Marmoker kombinieren, die auch in folgenden Formaten mit einer Stärke von **10 mm** hergestellt werden.

marmoker 59x118

granitoker



Asiago	•	•	•	•	•
Bardiglio Bianco	•	•	•	•	•
Bardiglio Imperiale	•	•	•	•	•
Birimbau	•	•	•	•	•
Breccia Argento	•	•	•	•	•
Canova	•	•	•	•	•
Crema Select	•	•	•	•	•
Giallo Striato	•	•	•	•	•
Nero Creta	•	•	•	•	•
Olimpo	•	•	•	•	•
Pulpis Tortora	•	•	•	•	•
Posato	•	•	•	•	•
Saint Laurent	•	•	•	•	•
Statuario Grigio	•	•	•	•	•
Statuario Oro	•	•	•	•	•
Travertino Bianco	•	•	•	•	•
Travertino Miele	•	•	•	•	•
Travertino Moka	•	•	•	•	•
Travertino Noce	•	•	•	•	•
Travertino Romano	•	•	•	•	•
Travertino Santa Caterina	•	•	•	•	•
Zebrino	•	•	•	•	•
Spessori Thicknesses	mm 10	mm 10	mm 10	mm 10	mm 10
Epaisseurs Stärken					

- Naturale Matt Naturelle Matt R9
- Lucida

Rettificata in un unico calibro. Single caliber, rectified version. Rectifiés en un unique calibre. Einem einzigen Werkmass maßgeschliffen geliefert.

Le lastre Kontinua si abbinano con tutti i colori della collezione Marmoker prodotti anche nei formati in spessore **10 mm**.
The Kontinua slabs match all the Marmoker collection colours, which are also produced in a 10 mm thick sizes. Les dalles Kontinua se combinent avec toutes les couleurs de la collection Marmoker, produites dans des formats d'une épaisseur de **10 mm**. Die Kontinua-Platten lassen sich mit allen Farben der Kollektion Marmoker kombinieren, die auch in folgenden Formaten mit einer Stärke von **10 mm** hergestellt werden.

marmoker 59x118 - 90x180

granitoker

Articoli prodotti nei formati cm 59x118 - cm 90x180 e sottomultipli. Items produced in size cm 59x118 - cm 90x180 size and submultiples. Articles fabriqués dans le format cm 59x118 - cm 90x180 et sous-multiples. Hergestellte Artikel im Format cm 59x118 - cm 90x180 und Unterformaten.



statuario oro 59x118

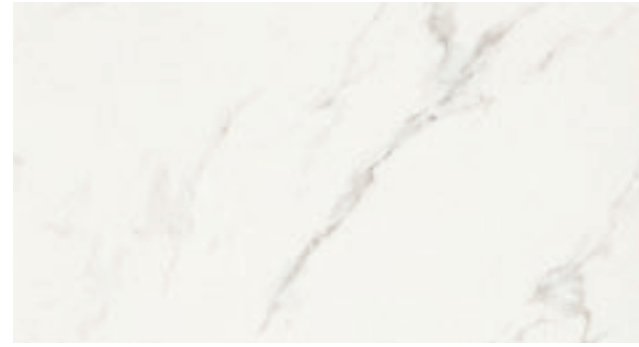

statuario grigio 59x118 - 90x180

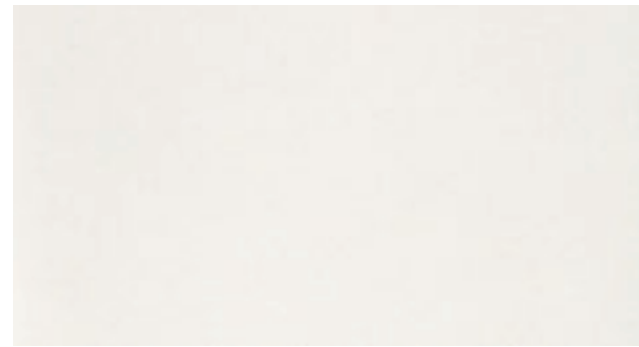

canova 59x118



asiago 59x118

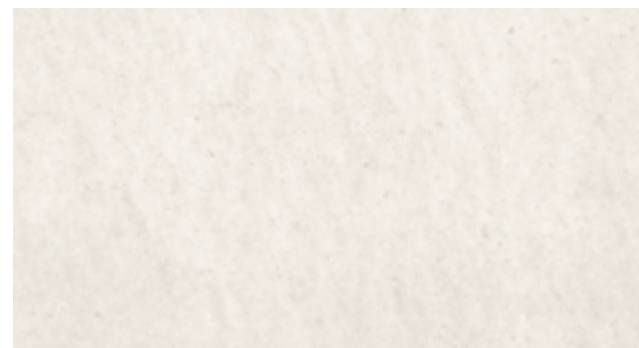

bianco vietnam 90x180



olimpo 59x118

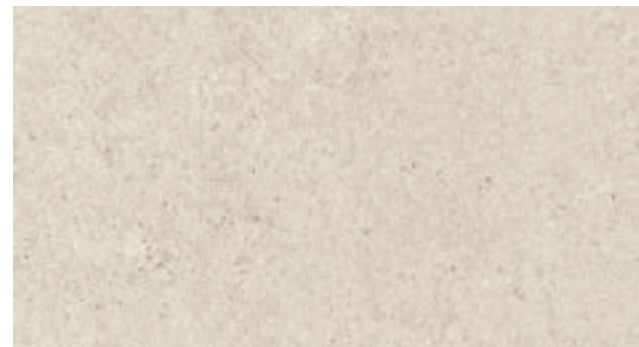

veselye 90x180



travertino bianco 59x118



bardiglio bianco 59x118

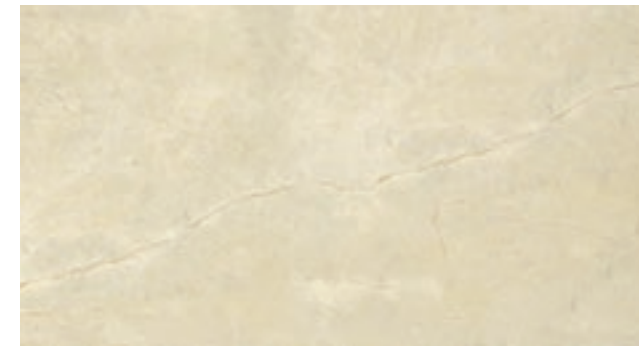

breccia argento 59x118



arabesque 90x180



zebrino 59x118



bardiglio imperiale 59x118



breccia carsica 90x180

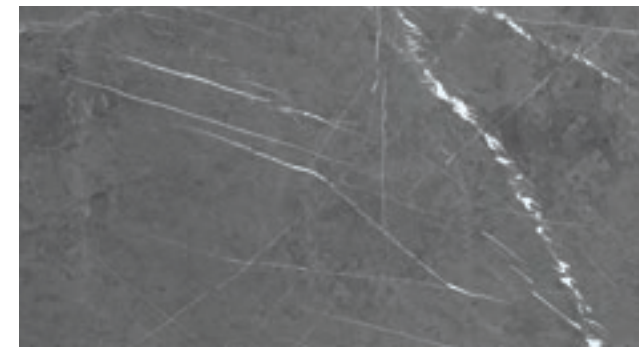

grafite 90x180



travertino titanium 90x180

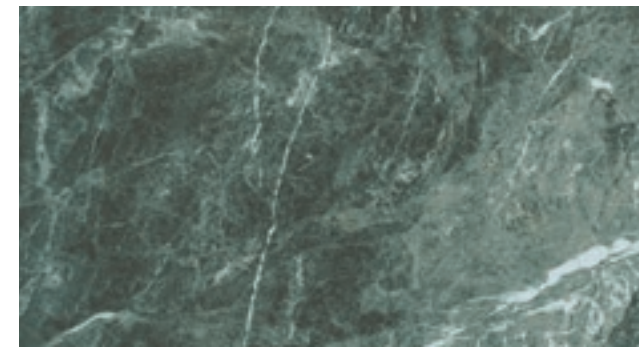

verde aver 90x180



nero creta 59x118

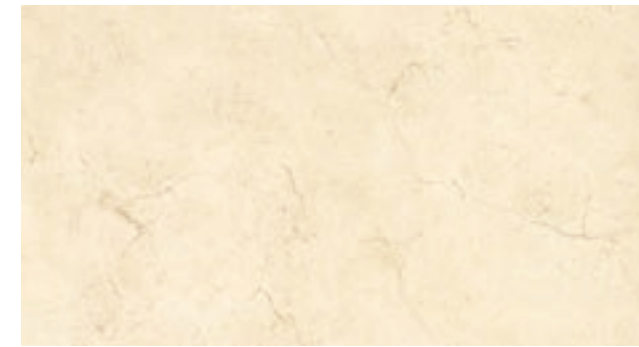

crema select 59x118



rosato 59x118

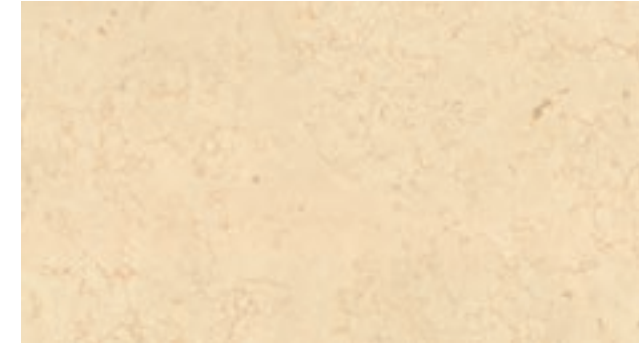

silvia oro 90x180

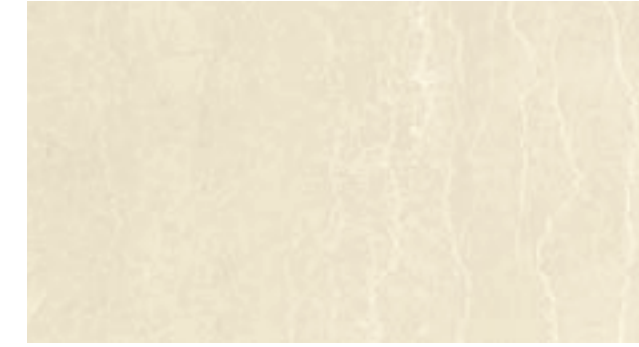

fiorito 90x180



travertino miele 59x118



travertino s.caterina 59x118



travertino romano 59x118

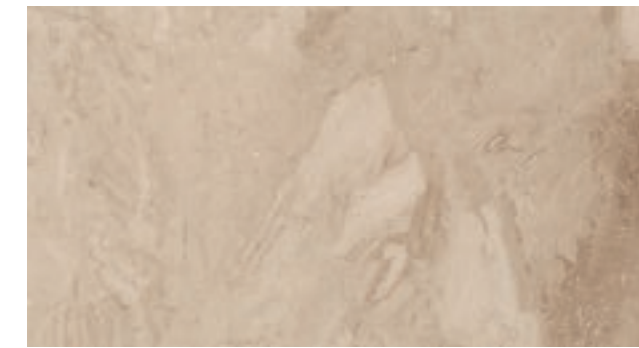

breccia sarda 90x180

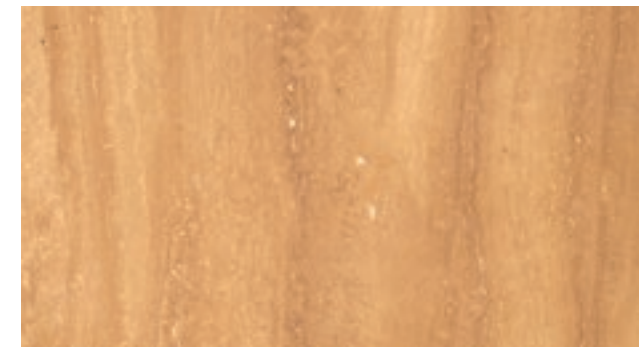

giallo striato 59x118

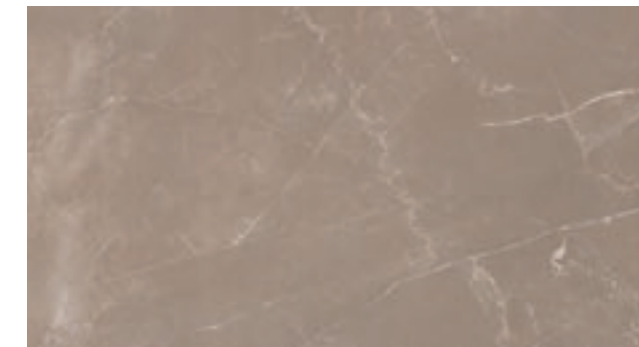

pulpis tortora 59x118



travertino noce 59x118

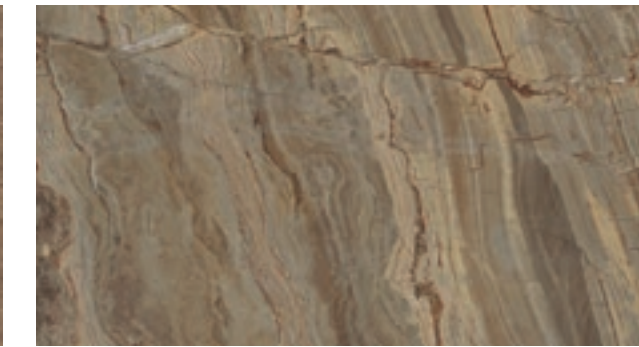

birimbau 59x118

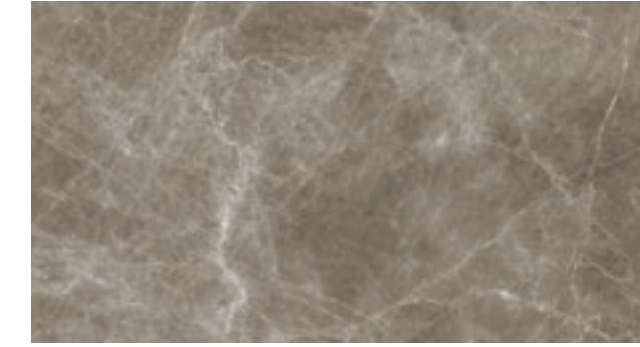

jolie 90x180



grigio billiemi 90x180

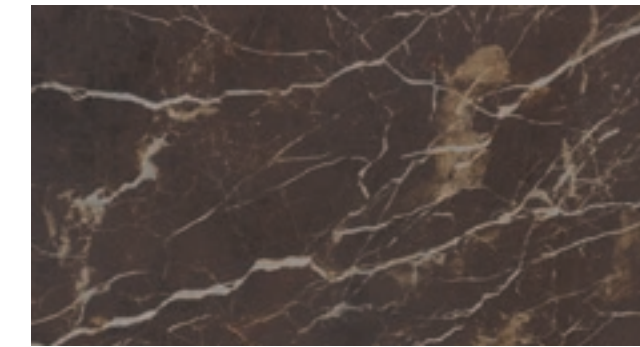

saint laurent 59x118

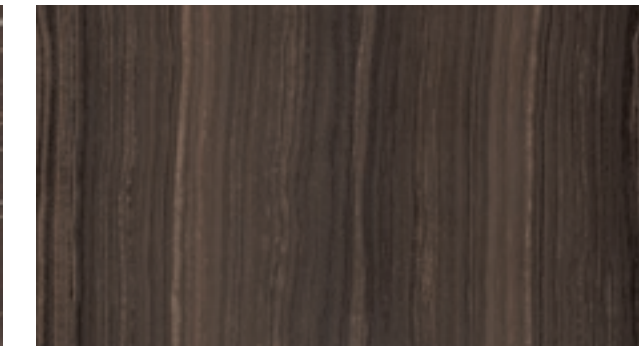

travertino moka 59x118

composizione **bookmatch**

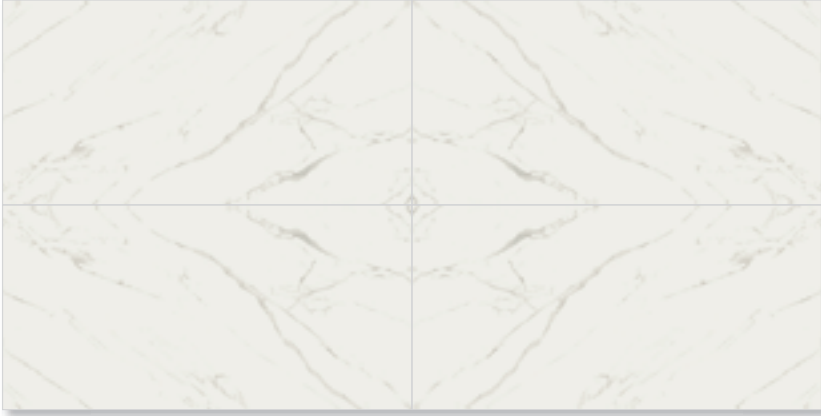

A sp	A
A	A sp

statuario grigio A statuario grigio A sp

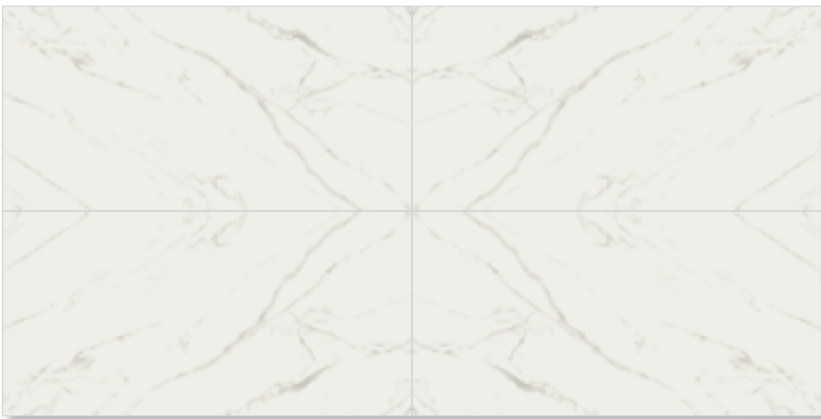

A	A sp
A sp	A

composizione **endmatch**

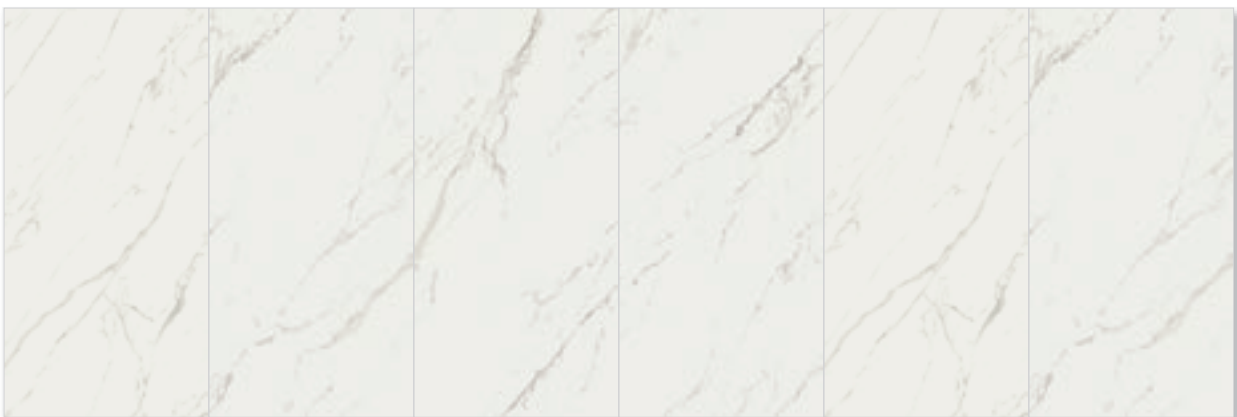

statuario grigio A statuario grigio B statuario grigio C statuario grigio D statuario grigio A statuario grigio B

composizione bookmatch & endmatch

marmoker **statuario oro**

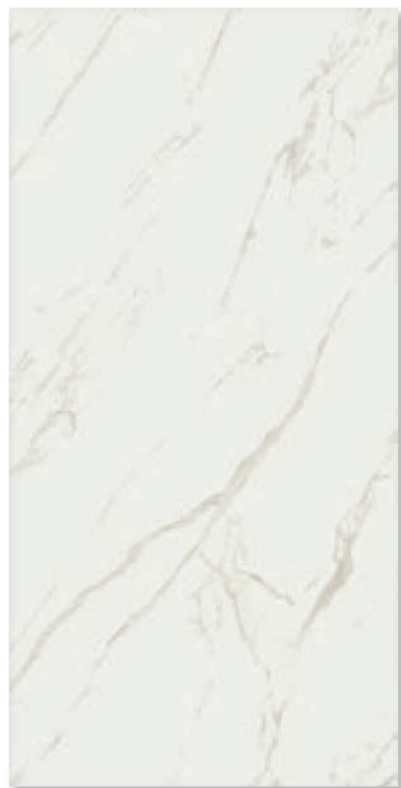

statuario oro A

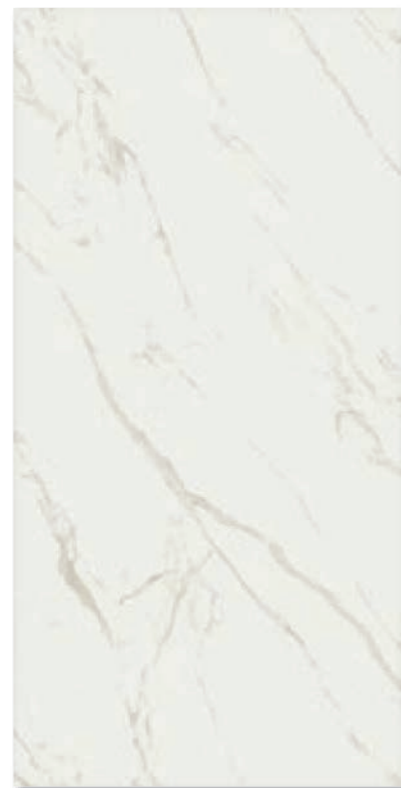

statuario oro A sp

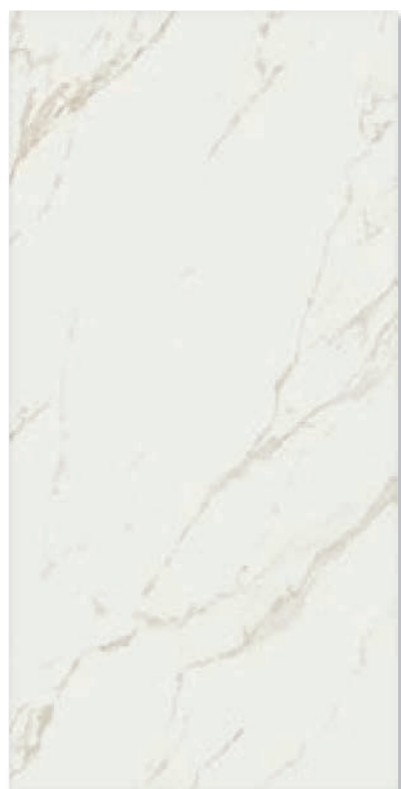

statuario oro B

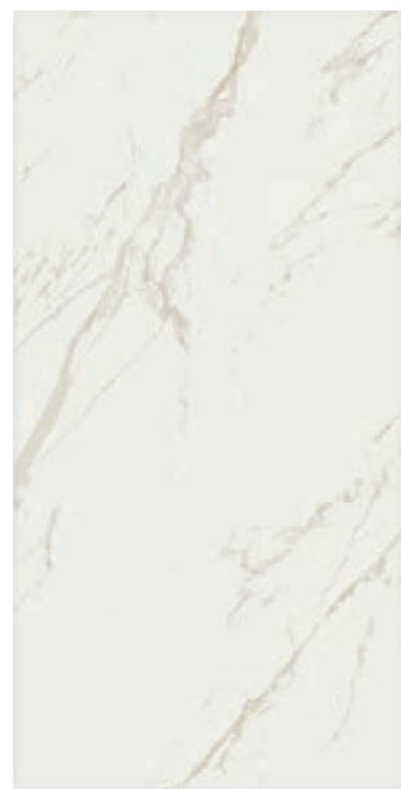

statuario oro C

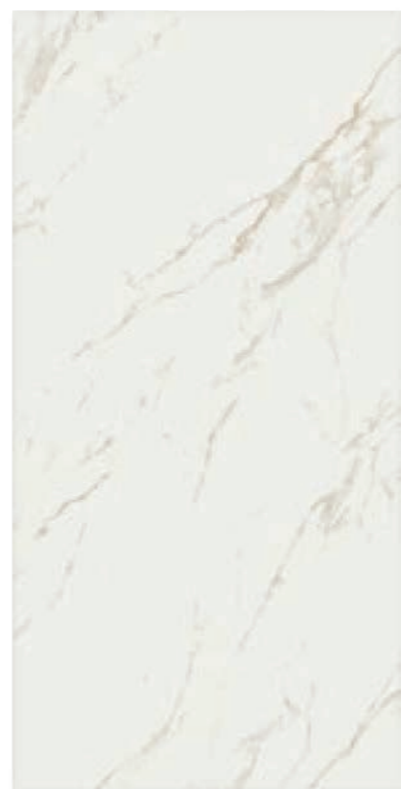

statuario oro D

composizione **bookmatch**

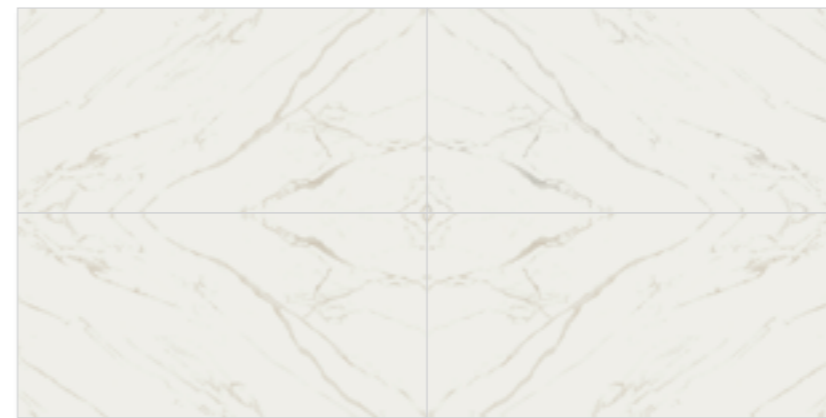

A sp	A
A	A sp

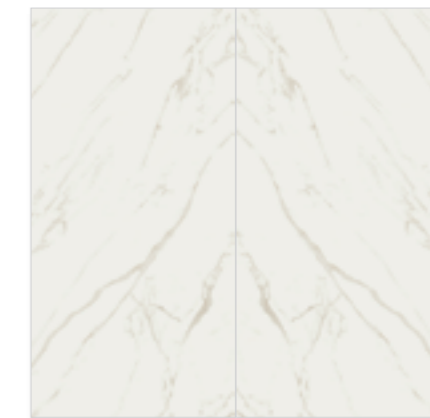

statuario oro A statuario oro A sp

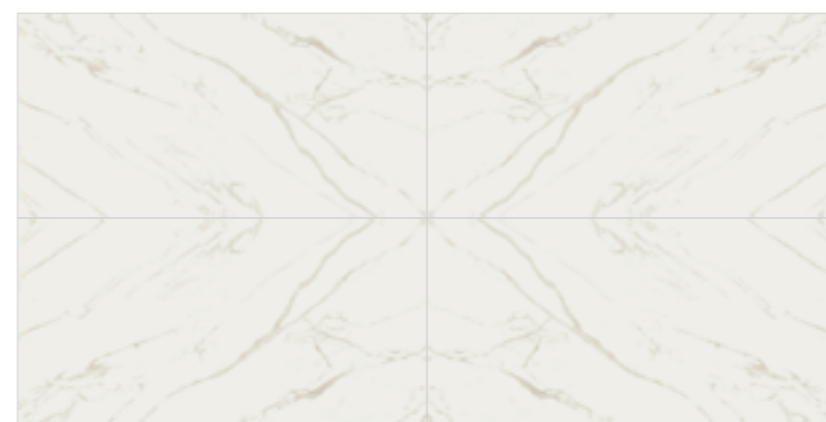

A	A sp
A sp	A

composizione **endmatch**

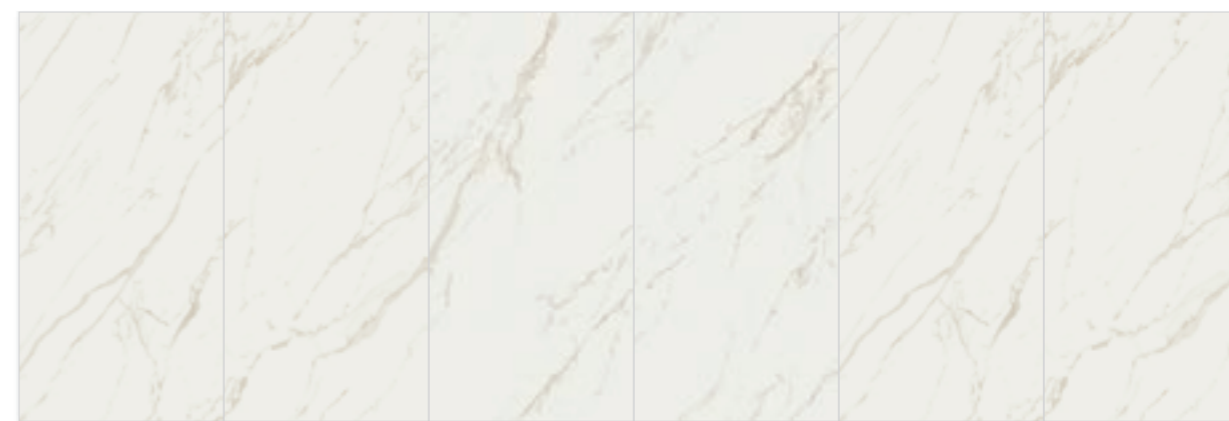

statuario oro A statuario oro B statuario oro C statuario oro D statuario oro A statuario oro B

composizione bookmatch

marmoker arabesque



arabesque A



arabesque A sp

composizione bookmatch



A sp	A
A	A sp



arabesque A

arabesque A sp



A	A sp
A sp	A



pietre di paragone pietre native



Grigio Aitos
Grigio Tao
Pietra del Cardoso





■ pietre di paragone grigio aitos





pietre di paragone grigio tao







pietre di paragone **K**ontinua

pietre native

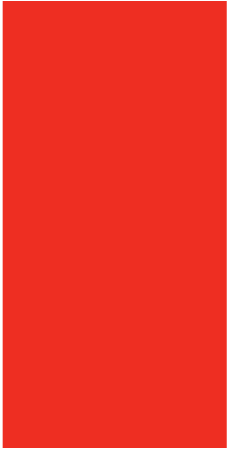
		
Formati Sizes Formats Formate	cm 60x120 23 ⁵ / ₈ "x47 ¹ / ₄ "	cm 120x120 47 ¹ / ₄ "x47 ¹ / ₄ "
Superfici Surfaces Surfaces Oberflächen	•	•
Spessori Thicknesses Epaisseurs Stärken	mm 6,5	mm 6,5 mm 10

			
Formati Sizes Formats Formate	cm 120x240 47 ¹ / ₄ "x94 ¹ / ₂ "	cm 120x260 47 ¹ / ₄ "x102 ³ / ₈ "	cm 160x320* 63"x126"
Superfici Surfaces Surfaces Oberflächen	•	•	•
Spessori Thicknesses Epaisseurs Stärken	mm 6,5	mm 6,5	mm 12

- Naturale Matt Naturelle Matt

* Disponibile nei colori Available in the colours Disponible dans les couleurs Verfügbar in den folgenden Farben:
Grigio Tao, Pietra del Cardoso

Le lastre Kontinua si abbinano con tutti i colori della collezione Pietre di paragone prodotti anche nei formati in spessore **10 mm - 9 mm**.
The Kontinua slabs match all the Pietre di paragone collection colours, which are also produced in a **10 mm** or **9 mm** thick sizes.
Les dalles Kontinua se combinent avec toutes les couleurs de la collection Pietre di paragone, également produites dans des formats
d'une épaisseur de **10 mm - 9 mm**. Die Kontinua-Platten lassen sich mit allen Farben der Kollektion Pietre di paragone kombinieren,
die auch in folgenden Formaten mit einer Stärke von **10 mm - 9 mm** hergestellt werden.

pietre di paragone 60x120

pietre native

pietre di paragone 90x180

pietre native

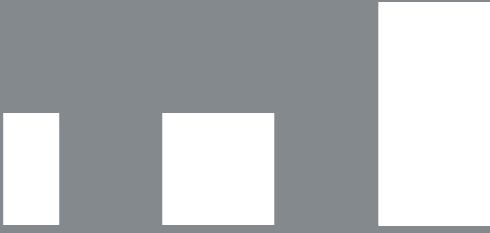

Formati Sizes Formats Formate	cm 30x60 11 ³ / ₄ "x23 ⁵ / ₈ "	cm 60x60 23 ⁵ / ₈ "x23 ⁵ / ₈ "	cm 60x120 23 ⁵ / ₈ "x47 ¹ / ₄ "
Black Pearl	•	•	•
Pietra Piasentina New	••	••	••*
Pietra del Cardoso	••	••	••*
Onsernone	••	••	••*
Vals	••	••	••*
Grigio Aitos	••	••	••*
Grigio Tao	••	••	••*
Jura Grigia	•••	•••	•••
Jura Beige	•••	•••	•••
Gré Grigio	••	••	••*
Gré Bianco	••	••	••*
Gré Nero	••	••	••*
Pietra di Vicenza	••	••	••*
Luni	••	••	••*
Spessori Thicknesses Epaisseurs Stärken	mm 10 mm 9	mm 10	mm 10

- Naturale Matt Naturelle Matt **R10** (Ad eccezione di Except for À l'exception de Mit Ausnahme von: Black Pearl)
- Grip **R12**

Rettificate in un unico calibro. Single caliber, rectified version. Rectifiés en un unique calibre. Einem einzigen Werkmass maßgeschliffen geliefert.

Le lastre Kontinua si abbinano con tutti i colori della collezione Pietre di paragone prodotti anche nei formati in spessore **10 mm - 9 mm**.
The Kontinua slabs match all the Pietre di paragone collection colours, which are also produced in a **10 mm or 9 mm** thick sizes.
Les dalles Kontinua se combinent avec toutes les couleurs de la collection Pietre di paragone, également produites dans des formats d'une épaisseur de **10 mm - 9 mm**. Die Kontinua-Platten lassen sich mit allen Farben der Kollektion Pietre di paragone kombinieren, die auch in folgenden Formaten mit einer Stärke von **10 mm - 9 mm** hergestellt werden.



Formati Sizes Formats Formate	cm 45x90 17 ³ / ₄ "x35 ³ / ₈ "	cm 90x90 35 ³ / ₈ "x35 ³ / ₈ "	cm 90x180 35 ³ / ₈ "x70 ⁷ / ₈ "
Black Pearl	•	•	•
Pietra Piasentina New	••*	••*	••*
Pietra del Cardoso	••*	••*	••*
Onsernone	••*	••*	••*
Vals	••*	••*	••*
Grigio Aitos	••*	••*	••*
Grigio Tao	••*	••*	••*
Jura Grigia	•••	•••	•••
Jura Beige	•••	•••	•••
Gré Grigio	••*	••*	••*
Gré Bianco	••*	••*	••*
Gré Nero	••*	••*	••*
Pietra di Vicenza	••*	••*	••*
Luni	••*	••*	••*
Spessori Thicknesses Epaisseurs Stärken	mm 10	mm 10	mm 10

- Naturale Matt Naturelle Matt **R10** (Ad eccezione di Except for À l'exception de Mit Ausnahme von: Black Pearl)
- Grip **R12**

Rettificate in un unico calibro. Single caliber, rectified version. Rectifiés en un unique calibre. Einem einzigen Werkmass maßgeschliffen geliefert.

pietre di paragone 60x120 - 90x180

pietre native

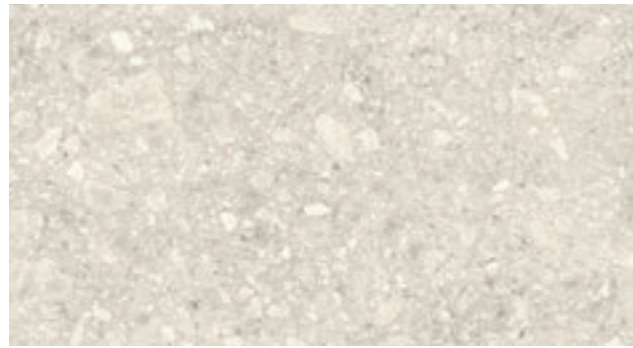

gré bianco 60x120

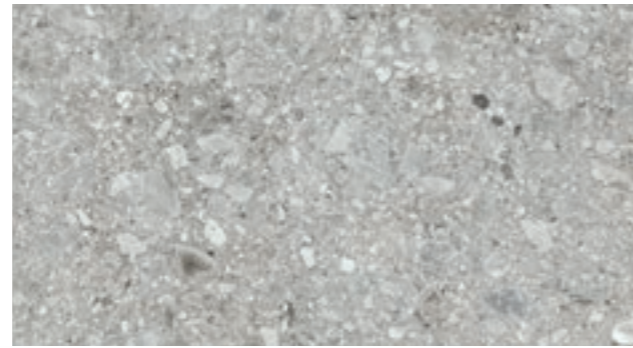

gré grigio 60x120

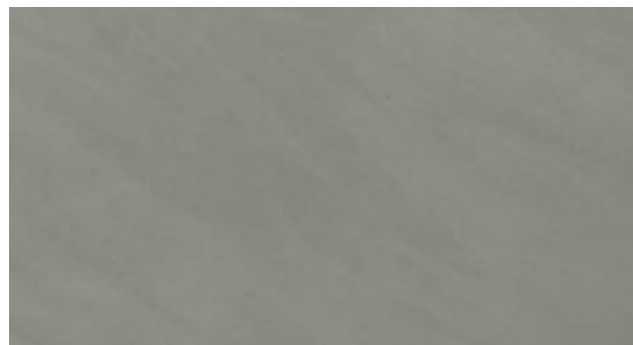

grigio aitos 60x120 - 90x180



grigio tao 60x120 - 90x180

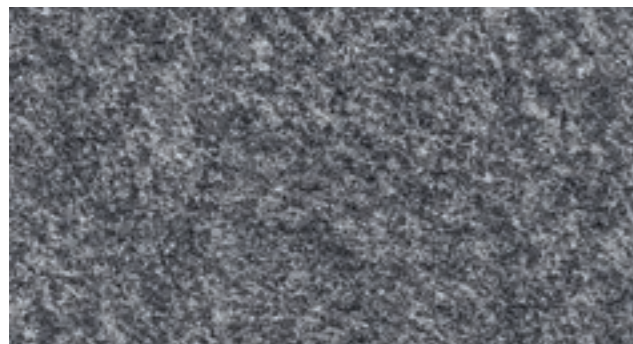

onsemome 60x120



vals 60x120

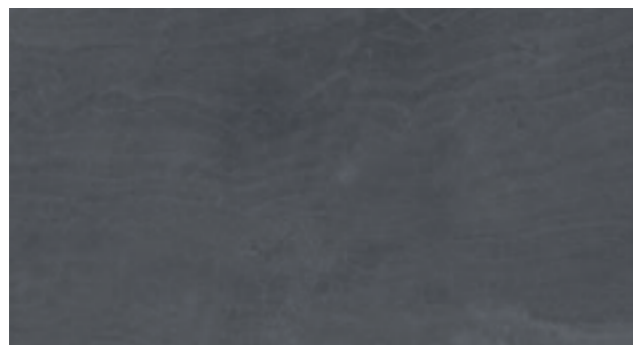

pietra del cardoso 60x120 - 90x180

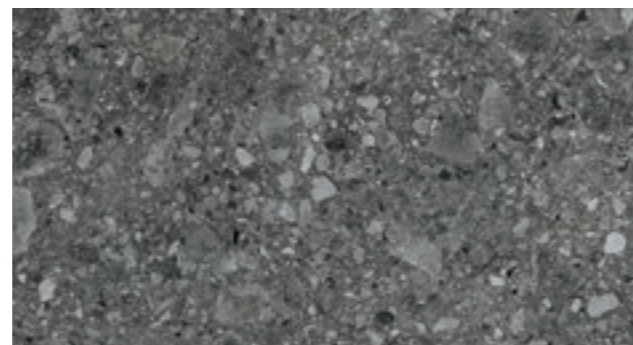

gré nero 60x120

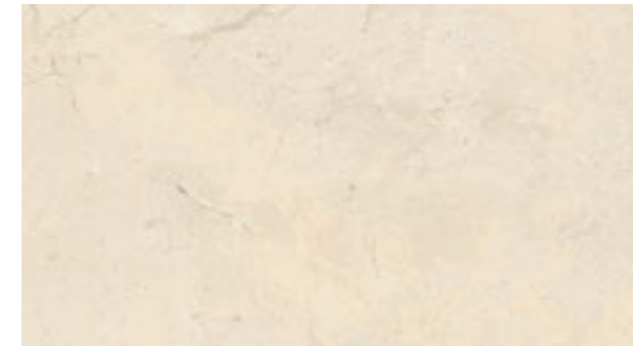

luni 60x120 - 90x180



pietra di vicenza 60x120 - 90x180

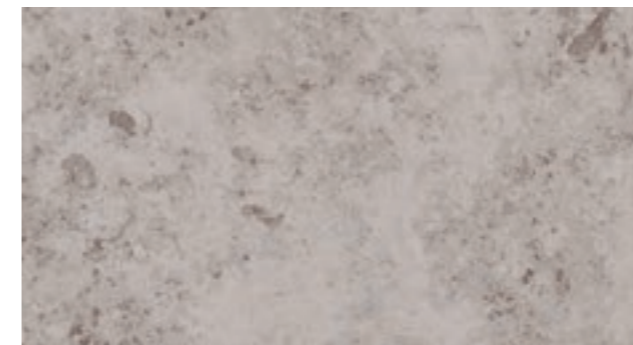

jura grigia 60x120

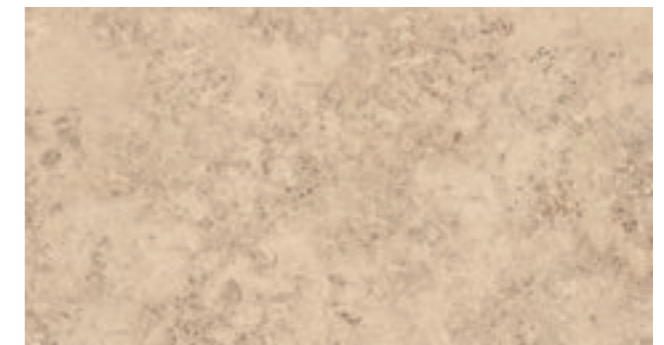

jura beige 60x120

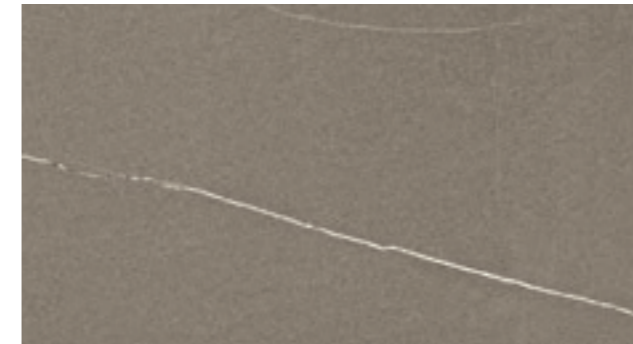

pietra piacentina new 60x120 - 90x180

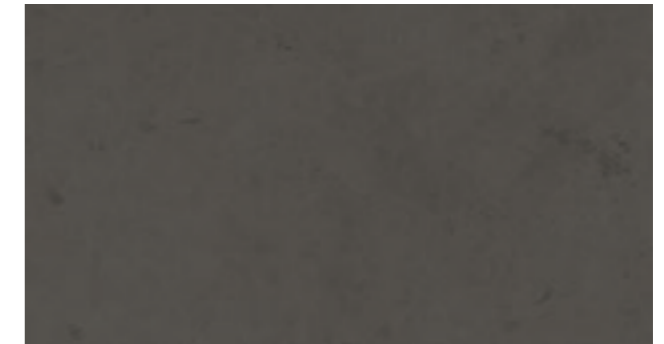

black pearl 60x120 - 90x180



pietre di sardegna pietre native

■
Punta Molara
Caprera
Porto Rotondo
Porto Cervo
Cala Luna
Tavolara





■ pietre di sardegna punta molara



■ pietre di sardegna caprera



■ pietre di sardegna porto rotondo



pietre di sardegna porto cervo



■ pietre di sardegna cala luna



■ pietre di sardegna tavolara



pietre di sardegna **K**ontinua

pietre native



Formati Sizes
Formats Formate

cm 60x120
23⁵/₈"x47¹/₄"

cm 120x120
47¹/₄"x47¹/₄"

Superfici Surfaces
Surfaces Oberflächen

•

•

Spessori Thicknesses
Epaisseurs Stärken

mm 6,5

mm 6,5
mm 10

Formati Sizes
Formats Formate

cm 120x240
47¹/₄"x94¹/₂"

cm 120x260
47¹/₄"x102³/₈"

cm 160x320*
63"x126"

Superfici Surfaces
Surfaces Oberflächen

•

•

•

Spessori Thicknesses
Epaisseurs Stärken

mm 6,5

mm 6,5

mm 12

• Naturale Matt Naturelle Matt **R10**

* Disponibile nei colori Available in the colours Disponible dans les couleurs Verfügbar in den folgenden Farben:
Porto Rotondo, Caprera

Le lastre Kontinua si abbinano con tutti i colori della collezione Pietre di Sardegna prodotti anche nei formati in spessore **10,5 mm - 9,4 mm - 9 mm - 4,9 mm**. The Kontinua slabs match all the Pietre di Sardegna collection colours, which are also produced in a **10,5 mm - 9,4 mm - 9 mm - 4,9 mm** thick sizes. Les dalles Kontinua se combinent avec toutes les couleurs de la collection Pietre di Sardegna, également produites dans des formats d'épaisseur de **10,5 mm - 9,4 mm - 9 mm - 4,9 mm**. Die Kontinua-Platten lassen sich mit allen Farben der Kollektion Pietre di Sardegna kombinieren, die auch in folgenden Formaten mit einer Stärke von **10,5 mm - 9,4 mm - 9 mm - 4,9 mm** hergestellt werden.

pietre di sardegna 90x90 - 60x120

pietre native

Formati Sizes Formats Formate	cm 15x15 5 7/8" x 5 7/8"	cm 30x30 11 3/4" x 11 3/4"	cm 45x45 17 3/4" x 17 3/4"	cm 15x60 5 7/8" x 23 5/8"	cm 30x60 11 3/4" x 23 5/8"	cm 60x60 23 5/8" x 23 5/8"
Superfici Surfaces Surfaces Oberflächen	● ●	● ●	● ●	● ●	● ●	● ●
Spessori Thicknesses Epaisseurs Stärken	mm 9,4	mm 9,4	mm 9 mm 4,9	mm 9,4	mm 10,5 mm 9,4	mm 10,5 mm 4,9

Formati Sizes Formats Formate	cm 45x90 17 3/4" x 35 3/8"	cm 90x90 35 3/8" x 35 3/8"	cm 60x120 23 5/8" x 47 1/4"
Superfici Surfaces Surfaces Oberflächen	● ●	● ●	● ●
Spessori Thicknesses Epaisseurs Stärken	mm 10,5 mm 4,9	mm 10,5	mm 10,5 mm 4,9

- Naturale Matt Naturelle Matt **R10A**
- Naturale Matt Naturelle Matt **R11** (60x60, 90x90)
- Lappata

Rettificata in un unico calibro. Single caliber, rectified version. Rectifiés en un unique calibre. Einem einzigen Werkmass maßgeschliffen geliefert.

Nel caso di combinazioni di formati di spessori diversi, specificarlo espressamente nell'ordine.
Please specify in your order if you wish to purchase formats including more than one thickness.
Prière de spécifier dans votre commande si vous souhaitez acheter des formats avec différentes épaisseurs.
Bitte weisen Sie im Bestellungsformular ausdrücklich darauf hin, wenn Sie Formatkombinationen mit verschiedenen Stärken wünschen.

Le lastre Kontinua si abbinano con tutti i colori della collezione Pietre di Sardegna prodotti anche nei formati in spessore **10,5 mm - 9,4 mm - 9 mm - 4,9 mm**. The Kontinua slabs match all the Pietre di Sardegna collection colours, which are also produced in a **10,5 mm - 9,4 mm - 9 mm - 4,9 mm** thick sizes. Les dalles Kontinua se combinent avec toutes les couleurs de la collection Pietre di Sardegna, également produites dans des formats d'une épaisseur de **10,5 mm - 9,4 mm - 9 mm - 4,9 mm**. Die Kontinua-Platten lassen sich mit allen Farben der Kollektion Pietre di Sardegna kombinieren, die auch in folgenden Formaten mit einer Stärke von **10,5 mm - 9,4 mm - 9 mm - 4,9 mm** hergestellt werden.

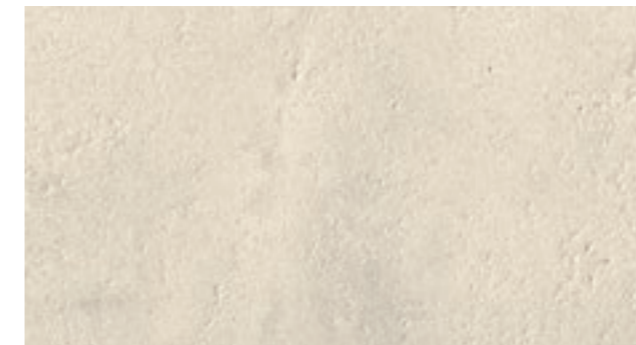

porto rotondo 60x120 - 90x90

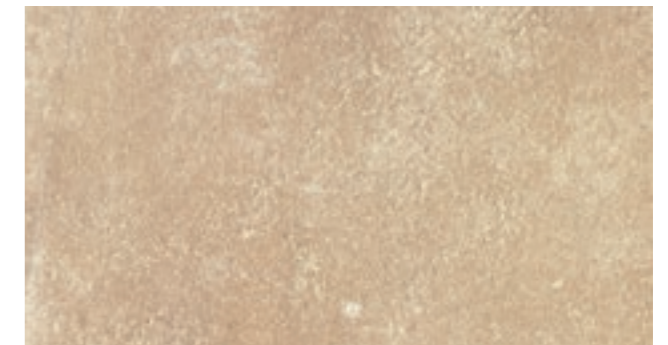

porto cervo 60x120 - 90x90



punta molaria 60x120 - 90x90

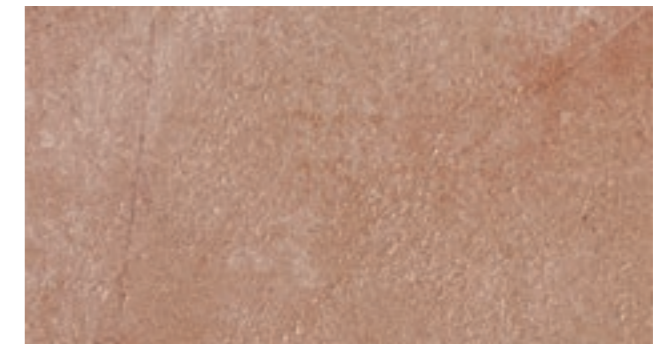

stentino 60x120 - 90x90

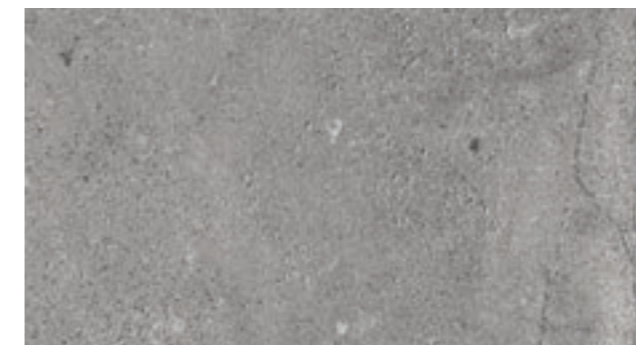

caprera 60x120 - 90x90

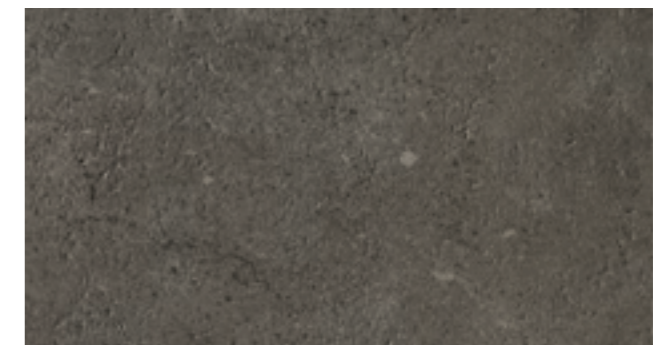

cala luna 60x120 - 90x90

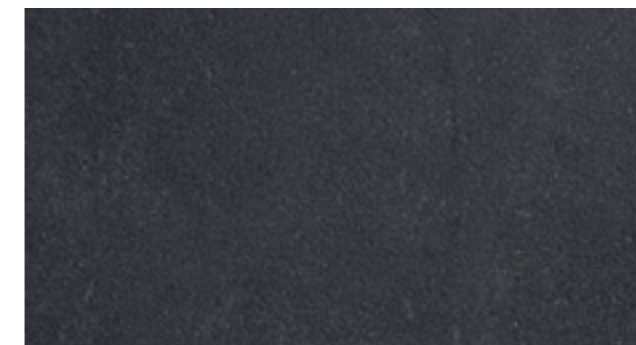

tavolara 60x120 - 90x90

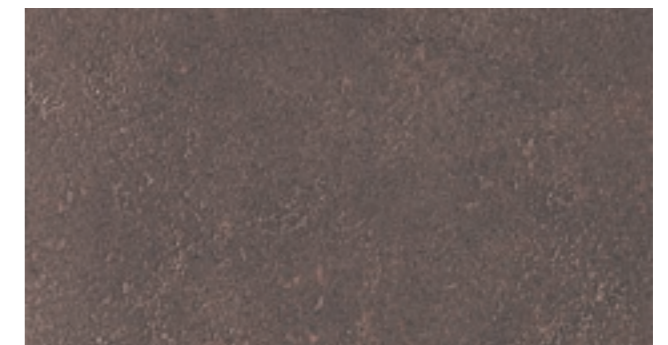

pevero 60x120 - 90x90



cemento granitoker

-
- Cassero Bianco
- Cassero Beige
- Cassero Grigio
- Cassero Antracite





cemento cassero bianco



cemento cassero beige



■ cemento cassero grigio



cemento cassero antracite



cemento KONTINUA

granitoker



Formati Sizes
Formats Formate

cm 60x120
23⁵/₈"x47¹/₄"

cm 120x120
47¹/₄"x47¹/₄"

Superfici Surfaces
Surfaces Oberflächen



Spessori Thicknesses
Epaisseurs Stärken

mm 6,5

mm 6,5
mm 10



Formati Sizes
Formats Formate

cm 120x240
47¹/₄"x94¹/₂"

cm 120x260
47¹/₄"x 102³/₈"

Superfici Surfaces
Surfaces Oberflächen



Spessori Thicknesses
Epaisseurs Stärken

mm 6,5

mm 6,5

• Cassero*

* Superficie non strutturata Untextured surface Surface non structurée nicht-strukturierte Oberfläche

Le lastre Kontinua si abbinano con tutti i colori della collezione Cemento prodotti anche nei formati in spessore **10,5 mm - 10 mm - 9,4 mm - 9 mm**. The Kontinua slabs match all the Cemento collection colours, which are also produced in a **10,5 mm - 10 mm - 9,4 mm - 9 mm** thick sizes. Les dalles Kontinua se combinent avec toutes les couleurs de la collection Cemento, également produites dans des formats d'une épaisseur de **10,5 mm - 10 mm - 9,4 mm - 9 mm**. Die Kontinua-Platten lassen sich mit allen Farben der Kollektion Cemento kombinieren, die auch in folgenden Formaten mit einer Stärke von **10,5 mm - 10 mm - 9,4 mm - 9 mm** hergestellt werden.

cemento 75,5x75,5 - 60x120

granitoker

Formati Sizes Formats Formate	cm 30x60 11 ³ / ₄ "x23 ⁵ / ₈ "	cm 60x60 23 ⁵ / ₈ "x23 ⁵ / ₈ "	cm 37,5x75,5 14 ³ / ₄ "x29 ³ / ₄ "	cm 75,5x75,5 29 ³ / ₄ "x29 ³ / ₄ "	cm 60x120 23 ⁵ / ₈ "x47 ¹ / ₄ "
Superfici Surfaces Surfaces Oberflächen	● ●	● ●	● ●	● ●	● ●
Spessori Thicknesses Epaisseurs Stärken	mm 10,5 mm 9,4	mm 10,5	mm 10 mm 9	mm 10	mm 10,5

● Cassero **R10**
● Rasato **R9**

Rettificate in un unico calibro. Single caliber, rectified version. Rectifiés en un unique calibre. Einem einzigen Werkmass maßgeschliffen geliefert.

Le lastre Kontinua si abbinano con tutti i colori della collezione Cemento prodotti anche nei formati in spessore **10,5 mm - 10 mm - 9,4 mm - 9 mm**. The Kontinua slabs match all the Cemento collection colours, which are also produced in a **10,5 mm - 10 mm - 9,4 mm - 9 mm** thick sizes. Les dalles Kontinua se combinent avec toutes les couleurs de la collection Cemento, également produites dans des formats d'une épaisseur de **10,5 mm - 10 mm - 9,4 mm - 9 mm**. Die Kontinua-Platten lassen sich mit allen Farben der Kollektion Cemento kombinieren, die auch in folgenden Formaten mit einer Stärke von **10,5 mm - 10 mm - 9,4 mm - 9 mm** hergestellt werden.



cassero bianco 75,5x75,5 - 60x120



K rasato bianco 75,5x75,5 - 60x120



cassero beige 75,5x75,5 - 60x120



K rasato beige 75,5x75,5 - 60x120



cassero grigio 75,5x75,5 - 60x120



K rasato grigio 75,5x75,5 - 60x120

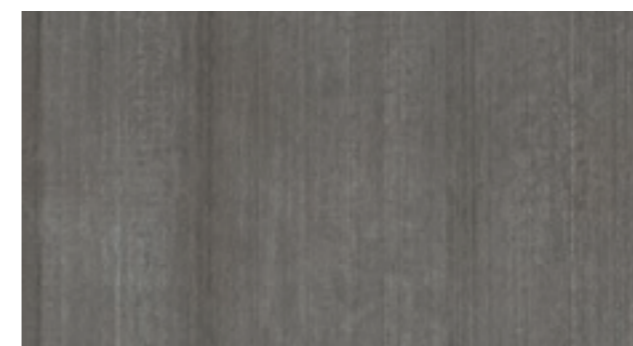

cassero antracite 75,5x75,5 - 60x120

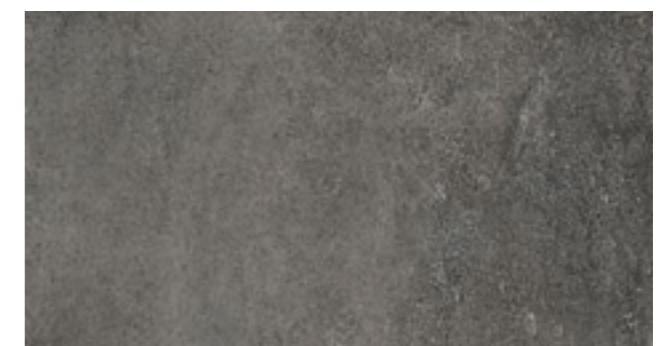

K rasato antracite 75,5x75,5 - 60x120

Kontinua decors

blue falls



cm 120x240 - 47¹/₄"x 94¹/₂"



Decoro abbinabile con la collezione Cemento Decor matching the Cemento collection
 Décor pouvant être associé à la collection Cemento Dekor kombinierbar mit den
 Kollektionen Cemento

optical

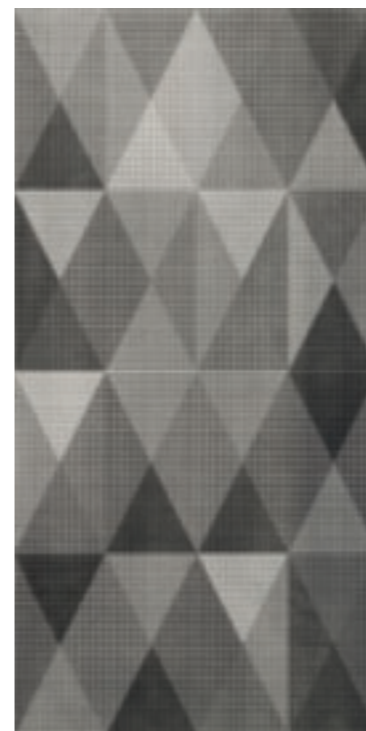

cm 120x240 - 47¹/₄"x 94¹/₂"



Decoro abbinabile con le collezioni Pietre di Paragone e Pietre di Sardegna Decor
 matching the Pietre di Paragone and Pietre di Sardegna collections Décor pouvant être
 associé aux collections Pietre di Paragone et Pietre di Sardegna Dekor kombinierbar
 mit den Kollektionen Pietre di Paragone und Pietre di Sardegna

Kontinua decors

diagonal



cm 120x240 - 47 1/4" x 94 1/2"



Decoro abbinabile con le collezioni Pietre di Paragone e Pietre di Sardegna
 matching the Pietre di Paragone and Pietre di Sardegna collections
 Décor pouvant être associé aux collections Pietre di Paragone et Pietre di Sardegna
 Dekor kombinierbar mit den Kollektionen Pietre di Paragone und Pietre di Sardegna

golden paint



cm 120x240 - 47 1/4" x 94 1/2"



Decoro abbinabile con le collezioni Pietre di Paragone, Pietre di Sardegna e Marmoker
 Decor matching the Pietre di Paragone, Pietre di Sardegna and Marmoker collections
 Décor pouvant être associé aux collections Pietre di Paragone, Pietre di Sardegna
 et Marmoker Dekor kombinierbar mit den Kollektionen Pietre di Paragone, Pietre di
 Sardegna und Marmoker

Kontinua decors

round square

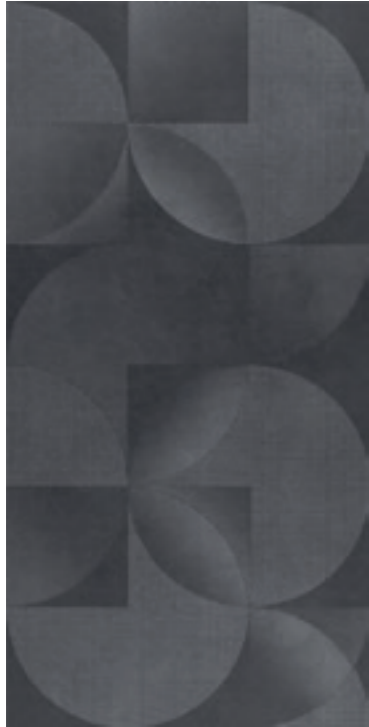

cm 120x240 - 47¹/₄"x 94¹/₂"



Decoro abbinabile con le collezioni Pietre di Paragone e Pietre di Sardegna Decor
 matching the Pietre di Paragone and Pietre di Sardegna collections Décor pouvant être
 associé aux collections Pietre di Paragone et Pietre di Sardegna Dekor kombinierbar
 mit den Kollektionen Pietre di Paragone und Pietre di Sardegna

tech info











CARATTERISTICHE TECNICHE TECHNICAL FEATURES
CARACTÉRISTIQUES TECHNIQUES TECHNISCHE EIGENSCHAFTEN



Kontinua



PIETRE NATIVE











	norma standards norme Norm	risultato prova* test results* resultats des essais* Ergebnisse*
 classificazione prodotto product classification classement Klassifizierung	UNI EN 14411-G ISO 13006	gruppo B1a completamente greificato group B1a fully vitrified group B1a grès cérame fin Gruppe B1a Feinsteinzeug
 caratteristiche dimensionali e d'aspetto dimensional and surface quality caractéristiques de la surface Oberflächenqualität	UNI EN ISO 10545-2	tolleranze minime nella 1ª scelta very low tolerance des tolérances minimales en 1er choix Entspricht Normen
 assorbimento di acqua water absorption absorption d'eau Wasseraufnahme	UNI EN ISO 10545-3	< 0,1%
 resistenza alla flessione flexural strength résistance à la flexion Biegezug-Festigkeit	UNI EN ISO 10545-4	> 45 N/mm ²
 resistenza al gelo frost resistance résistance au gel Frostwiderstandsfähigkeit	qualsiasi norma all standards toute norme alle normen	garantita guaranteed garantie Frostsicher
 resistenza attacco chimico (esclusione acido fluoridrico) resistance to acids and alkalis (with the exception of hydrofluoric acid) résistance à l'attaque chimique (exclusion de l'acide fluorhydrique) Säure und Laugen Beständigkeit (mit Ausnahme von Fluorwasserstoff)	UNI EN ISO 10545-13	nessuna alterazione no damage non attaquées nicht angegriffen
 resistenza usura e abrasione wear and abrasion resistance résistance à l'usure et abrasion Abriebhärte	UNI EN ISO 10545-6	≤ 150 mm ³
 dilatazione termica lineare linear thermal expansion coefficient linéaire de dilatation thermique Lineare Wärmeausdehnung	UNI EN ISO 10545-8	6 x 10 ⁻⁶
 resistenza alle macchie stain resistance résistance aux taches Fleckenfestigkeit	UNI EN ISO 10545-14	garantita guaranteed garantie Frostsicher
 resistenza dei colori alla luce colour resistance to sunlight exposure résistance de la couleur à la lumière Unveränderlichkeit der Farben wenn Strahlung zugesetzt wird	DIN 51094	nessuna variazione no change of colours couleurs inchangées Keinerlei Farbänderung

* valore indicativo approx value donnee approximative Ungefähre Werte

Kontinua









GRANITOKER







	norma standards norme Norm	risultato prova* test results* resultats des essais* Ergebnisse*
 classificazione prodotto product classification classement Klassifizierung	UNI EN 14411-G ISO 13006	gruppo B1a GL completamente greificato group B1a GL fully vitrified group B1a GL grès cérame fin Gruppe B1a GL Feinsteinzeug
 caratteristiche dimensionali e d'aspetto dimensional and surface quality caractéristiques de la surface Oberflächenqualität	UNI EN ISO 10545-2	tolleranze minime nella 1ª scelta very low tolerance des tolérances minimales en 1er choix Entspricht Normen
 assorbimento di acqua water absorption absorption d'eau Wasseraufnahme	UNI EN ISO 10545-3	< 0,1%
 resistenza alla flessione flexural strength résistance à la flexion Biegezug-Festigkeit	UNI EN ISO 10545-4	> 45 N/mm ²
 resistenza al gelo frost resistance résistance au gel Frostwiderstandsfähigkeit	qualsiasi norma all standards toute norme alle normen	garantita guaranteed garantie Frostsicher
 resistenza attacco chimico (esclusione acido fluoridrico) resistance to acids and alkalis (with the exception of hydrofluoric acid) résistance à l'attaque chimique (exclusion de l'acide fluorhydrique) Säure und Laugen Beständigkeit (mit Ausnahme von Fluorwasserstoff)	UNI EN ISO 10545-13	nessuna alterazione no damage non attaquées nicht angegriffen
 resistenza usura e abrasione wear and abrasion resistance résistance à l'usure et abrasion Abriebhärte	UNI EN ISO 10545-7	alta high haute hoch
 dilatazione termica lineare linear thermal expansion coefficient linéaire de dilatation thermique Lineare Wärmeausdehnung	UNI EN ISO 10545-8	6 x 10 ⁻⁶
 resistenza alle macchie stain resistance résistance aux taches Fleckenfestigkeit	UNI EN ISO 10545-14	garantita guaranteed garantie Frostsicher
 resistenza dei colori alla luce colour resistance to sunlight exposure résistance de la couleur à la lumière Unveränderlichkeit der Farben wenn Strahlung zugesetzt wird	DIN 51094	nessuna variazione no change of colours couleurs inchangées Keinerlei Farbänderung

* valore indicativo approx value donnee approximative Ungefähre Werte

PESI, MISURE E CONTENUTO DEI COLLI WEIGHT, SIZE AND CONTENTS OF THE PACKING
POIDS, DIMENSIONS, CONTENU DES COLIS VERPACKUNGSGRÖßEN/GEWICHTE

Kontinua		mm	 x 	 x 	 x 	 x 	 x 	 x 
----------	--	----	---	---	---	---	--	---

cm 60x120	23 ⁵ / ₈ "x47 ¹ / ₄ "	6,5	3	2,16	15	24	51,84	777,60
cm 59x118	23 ¹ / ₄ "x46 ¹ / ₂ "	6,5	3	2,09	15	24	50,11	751,68
cm 120x120	47 ¹ / ₄ "x47 ¹ / ₄ "	6,5	2	2,88	15	24	69,12	1036,8
cm 120x120	47 ¹ / ₄ "x 47 ¹ / ₄ "	10	1	1,44	24	30	43,20	1036,80
cm 118x118	46 ¹ / ₂ "x46 ¹ / ₂ "	6,5	2	2,78	15	24	66,81	1002,24
cm 120x240	47 ¹ / ₄ "x94 ¹ / ₂ "	6,5	1	2,88	15	20	57,60	864,00
cm 118x236	46 ¹ / ₂ "x92 ⁷ / ₈ "	6,5	1	2,78	15	20	55,68	835,20
cm 120x260	47 ¹ / ₄ "x102 ³ / ₈ "	6,5	1	3,12	15	20	62,40	936,00
cm 118x258	46 ¹ / ₂ "x101 ⁵ / ₈ "	6,5	1	3,04	15	20	60,88	913,20
cm 160x320	63"x126"	12	1	5,12	-	-	-	-

Kontinua		mm	 x 	 x 	 x 	 x 	 x 	 x 
----------	--	----	---	---	---	---	--	---

cm 15x15	5 ⁷ / ₈ "x5 ⁷ / ₈ "	9,4	40	0,90	21,6	64	57,60	1.244
cm 15x60	5 ⁷ / ₈ "x23 ⁵ / ₈ "	9,4	12	1,08	21,6	40	43,20	933
cm 30x30	11 ³ / ₄ "x11 ³ / ₄ "	9,4	12	1,08	21,6	48	51,84	1.120
cm 29,5x59,5	11 ⁵ / ₈ "x23 ¹ / ₄ "	10	5	0,87	24,0	48	41,76	1.002
cm 29,5x118	11 ⁵ / ₈ "x46 ¹ / ₂ "	10	3	1,04	24,0	36	37,44	899
cm 30x60	11 ³ / ₄ "x23 ⁵ / ₈ "	9	6	1,08	21,0	48	51,84	1.089
cm 30x60	11 ³ / ₄ "x23 ⁵ / ₈ "	9,4	6	1,08	21,6	48	51,84	1.120
cm 30x60	11 ³ / ₄ "x23 ⁵ / ₈ "	10	5	0,90	24,0	48	43,20	1.037
cm 30x60	11 ³ / ₄ "x23 ⁵ / ₈ "	10,5	5	0,90	25,0	48	43,20	1.080
cm 37,5x75,5	14 ¹ / ₂ "x29 ³ / ₄ "	9	4	1,13	21,0	54	61,02	1.281
cm 37,5x75,5	14 ¹ / ₂ "x29 ³ / ₄ "	10	4	1,13	24,0	48	54,24	1.302

Kontinua		mm	 x 	 x 	 x 	 x 	 x 	 x 
----------	--	----	---	---	---	---	---	---

cm 45x45	17 ³ / ₄ "x17 ³ / ₄ "	4,9	10	2,03	11,3	34	68,85	778
cm 45x45	17 ³ / ₄ "x17 ³ / ₄ "	9	5	1,01	21,6	34	34,41	743
cm 45x90	17 ³ / ₄ "x35 ³ / ₈ "	4,9	6	2,43	11,3	30	72,90	824
cm 45x90	17 ³ / ₄ "x35 ³ / ₈ "	10,5	3	1,22	25,0	30	36,45	911
cm 59x59	23 ¹ / ₄ "x23 ¹ / ₄ "	10	4	1,39	24,0	30	41,70	1.001
cm 59x118	23 ¹ / ₄ "x46 ¹ / ₂ "	10	2	1,39	24,0	24	33,36	801
cm 60x60	23 ⁵ / ₈ "x23 ⁵ / ₈ "	4,9	8	2,88	11,3	30	86,40	976
cm 60x60	23 ⁵ / ₈ "x23 ⁵ / ₈ "	10	4	1,44	25,0	30	43,20	1.080
cm 60x60	23 ⁵ / ₈ "x23 ⁵ / ₈ "	10,5	4	1,44	25,0	30	43,20	1.080
cm 60x120	23 ⁵ / ₈ "x47 ¹ / ₄ "	4,9	4	2,88	11,3	24	69,12	781
cm 60x120	23 ⁵ / ₈ "x47 ¹ / ₄ "	10	2	1,44	24,0	24	34,56	829
cm 60x120	23 ⁵ / ₈ "x47 ¹ / ₄ "	10,5	2	1,44	25,0	24	34,56	864
cm 75,5x75,5	29 ³ / ₄ "x29 ³ / ₄ "	10	2	1,14	24,0	45	51,30	1.231
cm 90x90	35 ³ / ₈ "x35 ³ / ₈ "	10	2	1,62	24,0	24	38,88	933
cm 90x90	35 ³ / ₈ "x35 ³ / ₈ "	10,5	2	1,62	25,0	24	38,88	972
cm 90x180	35 ³ / ₈ "x70 ⁷ / ₈ "	10	1	1,62	24,0	30	48,60	1.166

ISTRUZIONI DI MOVIMENTAZIONE HANDLING INSTRUCTIONS
INSTRUCTIONS DE MANUTENTION ANLEITUNG ZUR HANDHABUNG



Dotarsi di tutti i dispositivi di sicurezza individuale necessari durante la movimentazione delle lastre singole. Use all necessary personal protective equipment when moving the individual slabs. Se doter de tous les équipements de protection individuelle nécessaires pour la manutention des différentes dalles. Tragen Sie bei der Handhabung der einzelnen Platten immer die gesamte erforderliche persönliche Schutzausrüstung.

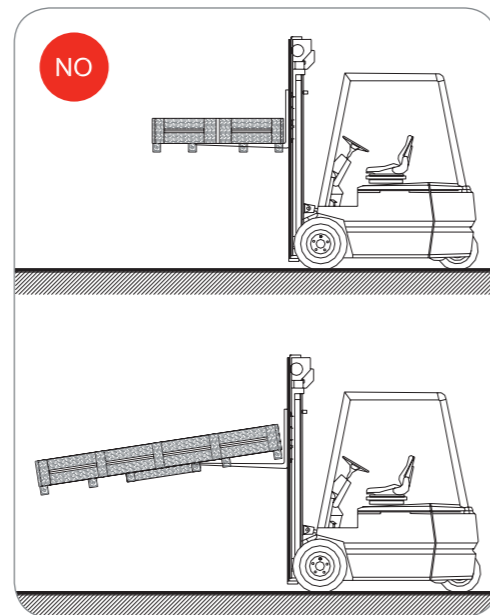
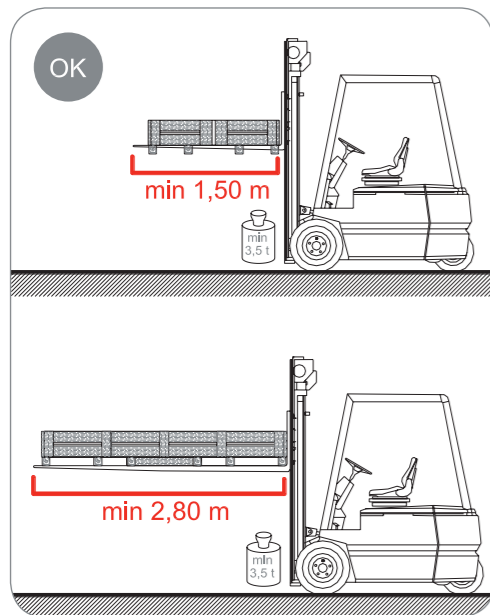

Utilizzare carrelli di idonea portata e lunghezze forche commisurate alle misure delle casse. Use lift trucks with the correct capacity and a fork length that matches the dimensions of the crates. Utiliser des chariots dont la portée et la longueur des fourches répondent aux mesures des caisses. Verwenden Sie Transportwagen mit geeigneter Tragkraft und Hebegabeln, die der Länge der Kistenmaße entsprechen.

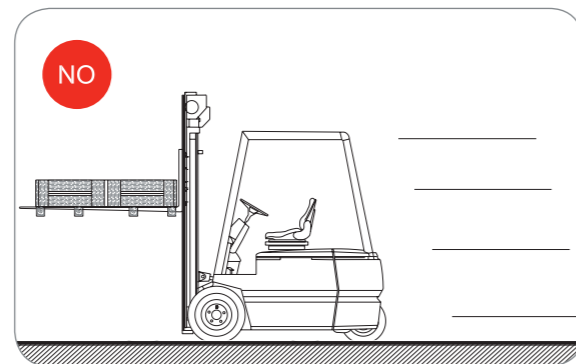
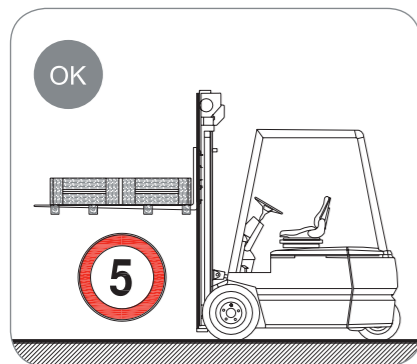

Movimentare la cassa con cautela e mantenere una velocità ridotta per tutto il tragitto. Move the crate with care, maintaining a slow speed for the entire journey. Déplacer la caisse avec précaution et progresser à vitesse modérée pendant tout le déplacement. Bewegen Sie die Kiste über den gesamten Transportweg vorsichtig und langsam.

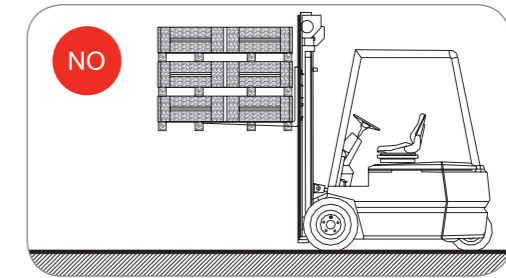
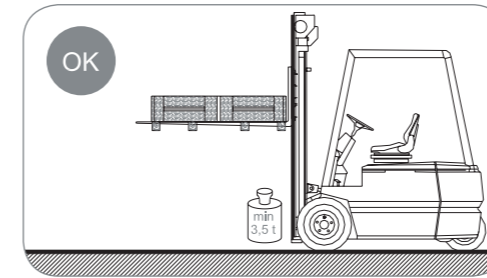

Movimentare sempre una sola cassa alla volta. Never move more than one crate at a time. Ne déplacer qu'une seule caisse à la fois. Bewegen Sie immer nur jeweils eine Kiste.

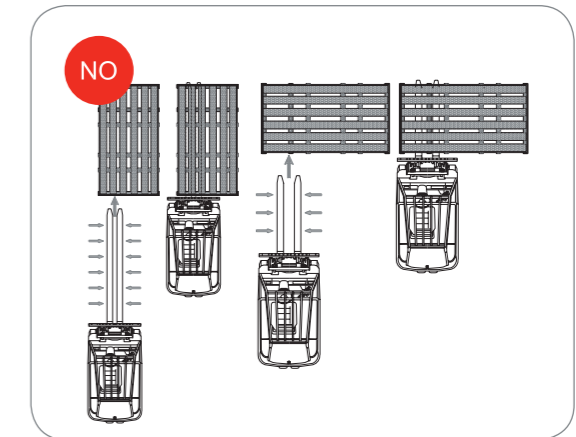
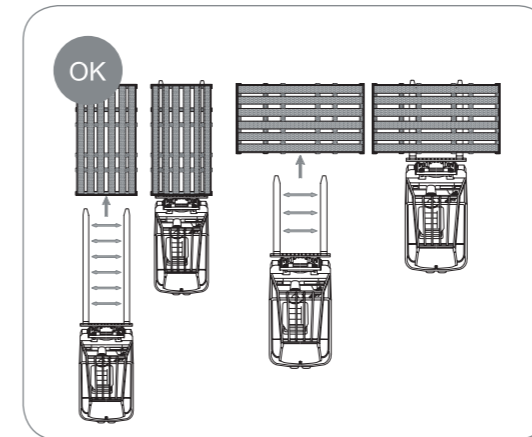

Aprire le forche fino alla massima apertura possibile ed inforcare nel centro esatto della cassa. Open the forks to their maximum extension and pick up the crate in the very centre. Ouvrir les fourches jusqu'à l'ouverture maximum possible et enfiler les fourches au centre exact de la caisse. Öffnen Sie die Hebegabel bis zur maximal möglichen Öffnungsstellung und führen Sie sie genau an der Mitte der Kiste ein.

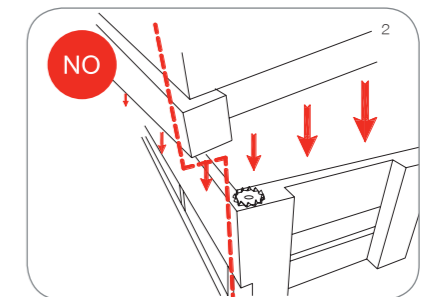
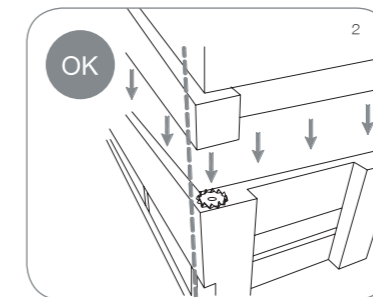

¹ Le rosette metalliche deputate alla sovrapposizione delle casse sono appuntite e possono ferire in caso di urto! Non toccarle in nessun modo. The metal washers used for stacking crates are sharp and can cause injury on impact! Do not touch them. Les rondelles métalliques dentelées qui servent à superposer les caisses sont pointues et peuvent causer des blessures en cas de chocs ! Il ne faut les toucher sous aucun prétexte. Die Metallrosetten zum Übereinanderstellen der Kisten sind spitz und können beim Anstoßen Verletzungen verursachen. Berühren Sie sie keinesfalls.

² Durante la sovrapposizione delle casse, avere cura di centrare esattamente la rosetta della cassa sottostante. When stacking crates, ensure the washers on the crate below are completely central. Au cours de la superposition des caisses, prendre soin de centrer de manière exacte la rondelle dentelée de la caisse sous-jacente. Achten Sie beim Übereinanderstellen der Kisten darauf, dass die Rosetten exakt mit denen der darunterstehenden Kiste ausgerichtet sind.

ISTRUZIONI DI MOVIMENTAZIONE HANDLING INSTRUCTIONS
INSTRUCTIONS DE MANUTENTION ANLEITUNG ZUR HANDHABUNG

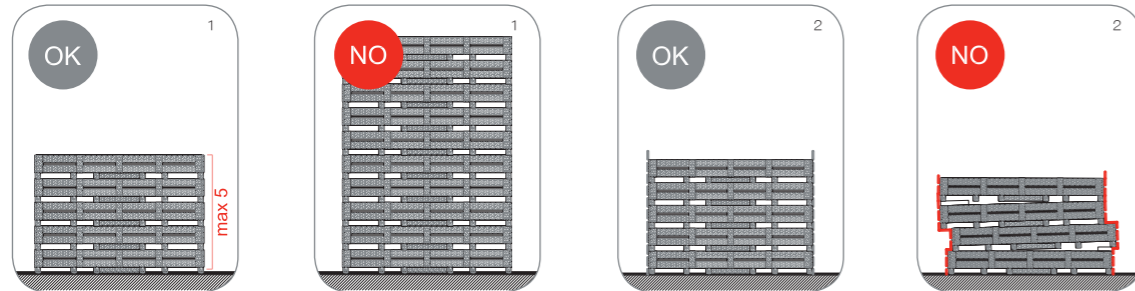

¹ Sovrapposizione in stock per un massimo di 5 casse. When storing the crates, do not stack more than five in a single pile. Superposition en stock à concurrence d'un maximum de 5 caisses. Zur Lagerung dürfen maximal nur 5 Kisten übereinandergestellt werden.

² Curare il perfetto allineamento degli imballi in fase di impilaggio onde evitare problemi di stabilità della pila. Ensure the crates are perfectly aligned when stacking, otherwise they could be unstable. Veiller à l'alignement parfait des emballages au cours de la phase d'empilage, pour éviter tout problème de stabilité. Achten Sie beim Übereinanderstellen auf die perfekte Ausrichtung der Kisten, um die Stabilität des Stapels nicht zu gefährden.

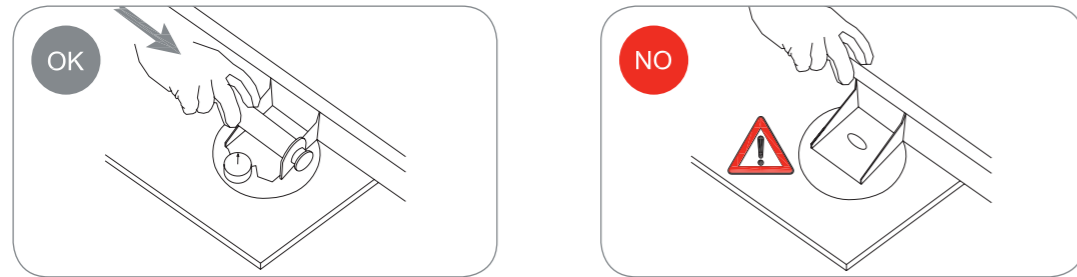

Nella movimentazione delle lastre singole, preferire telai a ventosa con vuoto controllato. When moving individual slabs, use controlled vacuum lifting frames where possible. Au cours du déplacement des différentes dalles, préférer des cadres à ventouses à vide contrôlé. Beim Bewegen von einzelnen Platten sollte ein Saugnapfrahmen mit Vakuumkontrolle verwendet werden.

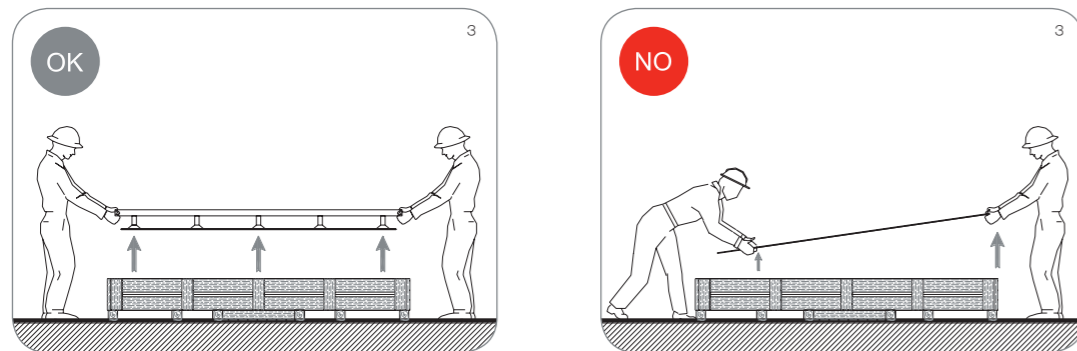

Sollevarre sempre le lastre dalla cassa con opportuni telai a ventosa. Always lift the slabs from the case using suitable vacuum lifting frames. Il faut toujours soulever les plaques de la caisse avec des cadres à ventouses appropriés. Heben Sie die Platten immer mit einem geeigneten Saugnapfrahmen aus der Kiste.

³ Movimentare la lastra adagio, evitando il più possibile brusche oscillazioni o vibrazioni del materiale. Move the slabs slowly, avoiding any sudden swinging or vibration as far as possible. Déplacer lentement la dalle, en évitant le plus possible toutes brusques oscillations ou vibrations du matériel. Bewegen Sie die Platte sanft und vermeiden Sie so weit wie möglich abrupte Schwingungen oder Vibrationen des Materials.

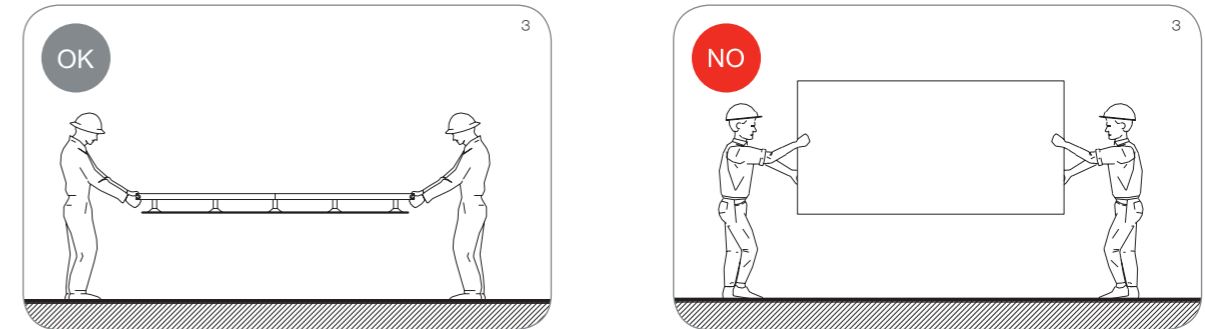

Utilizzare telai muniti di ventose a vuoto controllato. Use controlled vacuum lifting frames. Utiliser des cadres munis de ventouses à vide contrôlé. Verwenden Sie Rahmen mit vakuumkontrollierten Saugnapfen.

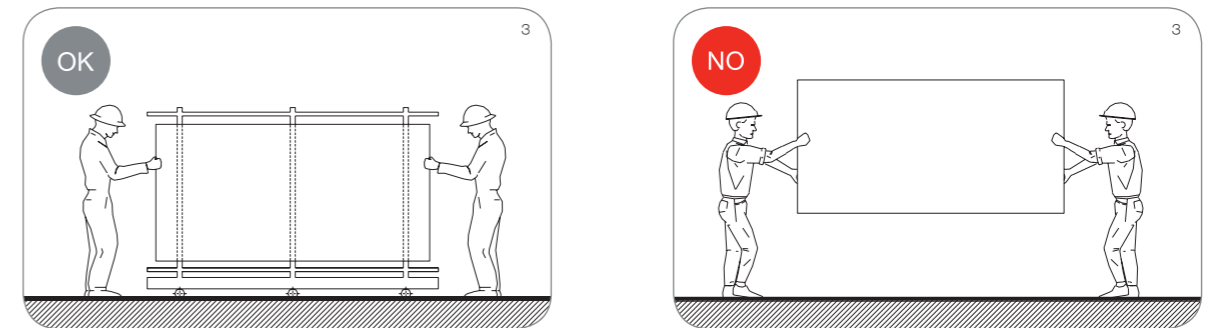

È possibile fissare il telaio a ventosa su supporto stabile che ne consenta la movimentazione in posizione verticale e la successiva spalmatura del collante (telai verticali mobili). The vacuum lifting frame can be attached to a stable support so it can be moved in a vertical position and adhesive can be applied (movable vertical frames). Il est possible de fixer le cadre à ventouses sur un support stable qui en permet le déplacement en position verticale et l'étalement ultérieur de la substance collante (cadres verticaux mobiles). Der Saugnapfrahmen kann auf einer stabilen Unterlage befestigt werden, die eine vertikale Bewegung und das anschließende Bestreichen der Platte mit Klebemittel ermöglicht (mobile vertikale Rahmen).

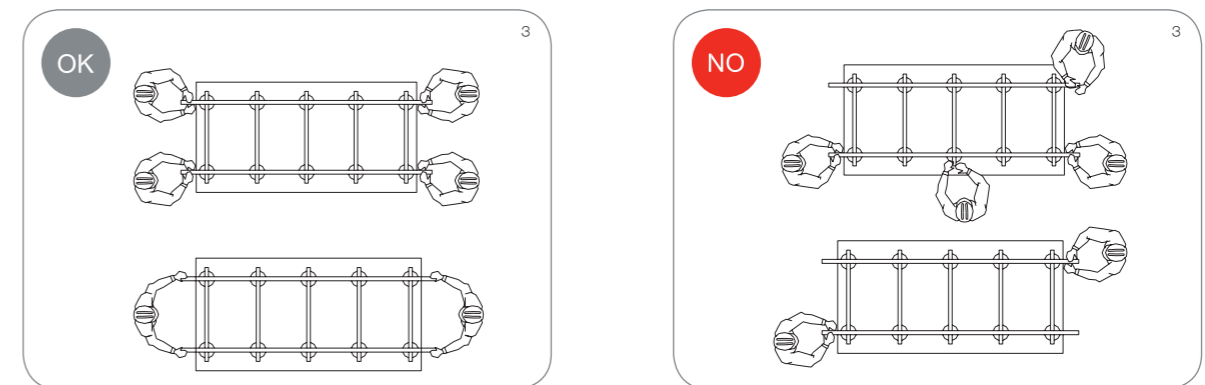

La movimentazione avviene tramite telai a ventosa, trasportati da minimo 2 operatori (meglio ancora 4) posizionati in ciascun vertice della lastra. Slabs should be moved using vacuum lifting frames held by a minimum of two people (ideally four), positioned at each end of the slab. La manutention a lieu à l'aide de cadres à ventouses, transportés par un minimum de 2 opérateurs (de préférence 4), placés à chaque sommet de la dalle. Die Handhabung erfolgt mithilfe eines Saugnapfrahmens, der von mindestens zwei Mitarbeitern (noch besser 4) an jeder Ecke der Platte gehalten werden muss.

MANUTENZIONE E PULIZIA

Un pavimento o rivestimento murale **Casalgrande Padana** sia nella versione *naturale* che *lappata*, *lucida*, o *levigata*, è sinonimo di bellezza, durata e resistenza nel tempo. La sua manutenzione non richiede particolari cure se non l'attenersi alle seguenti norme di pulizia.

Prima pulizia

Ha lo scopo di eliminare ogni traccia di cemento o stucco conseguente alla chiusura dei giunti. Si esegue normalmente una sola volta prima dell'utilizzo del pavimento/rivestimento e deve essere obbligatoriamente eseguita dopo la posa in opera e prima dell'uso del pavimento/rivestimento. Procedere nel modo seguente:

1. Spazzare il pavimento/rivestimento raccogliendo lo sporco grossolano.
2. Inumidire con acqua la superficie affinché le fughe vengano impregnate e pertanto protette dall'azione corrosiva del detergente a componente acida (decalcificante).
3. Stendere il detergente (vedi nota A) nella concentrazione (rapporto di miscelazione con l'acqua) indicata dal produttore, applicandolo con una spazzola manuale o motorizzata. Evitare che il detergente acido venga a contatto con componenti di acciaio, alluminio e marmo naturale adiacenti al pavimento/rivestimento.
4. Durante il tempo d'azione, che deve essere stabilito in relazione allo stato del pavimento, strofinare lo sporco più ostinato (e raschiare eventuali residui di malta, stucco, etc...).
5. Sciacquare il pavimento/rivestimento con acqua e raccogliere subito l'acqua sporca (manualmente o con un apparecchio lavasciuga).

Se la prima pulizia viene eseguita dopo che il pavimento/rivestimento è già stato usato, sarà bene, prima dell'applicazione del detergente a base acida, togliere con appositi detersivi alcalini (sgrassanti) eventuali presenze di sostanze grasse o simili (vedi Pulizia ordinaria).
L'operazione di prima pulizia, se ritenuto necessario, può essere ripetuta.

Superficie levigata, lucida e lappata

Una leggera diminuzione della lucentezza dei pavimenti levigati, a seguito del primo lavaggio acido del pavimento, deve essere considerata normale, perché dovuta alla eliminazione dei residui degli abrasivi utilizzati nella lavorazione della superficie.

A) Alcuni detergenti consigliati per eliminare i residui di stucco *Fughe realizzate con stucco cementizio - detergenti a componente acida (decalcificanti):*

Deterprimo plus (Casalgrande Padana), Deterdek (Fila), Keranet (Mapei), Deltaplus (Kerakoll), Solvacid (Geal) o simili (seguire istruzioni del produttore del detergente).

Fughe realizzate con stucco epossidico – detergenti a componente alcalina:

Fuga-Soap Eco (Kerakoll), Kerapoxy Cleaner (Mapei), Tile Cleaner (Faber), CR10 (Fila), Lithofin Resin-Ex (Lithofin), Eposolv (Geal) o simili (seguire istruzioni del produttore del detergente).

Pulizia ordinaria

Per la pulizia di tutti i giorni è sufficiente lavare il pavimento/rivestimento con acqua e aggiunta di normali prodotti detergenti adatti a pulire superfici ceramiche (per i rivestimenti utilizzare detergenti in gel).

*Assicurarsi che i detergenti non contengano sostanze cerose; la superficie dei prodotti **Casalgrande Padana**, essendo praticamente inassorbente, non richiede l'applicazione di cere e/o prodotti silconici di protezione che, al contrario, non debbono mai essere usati (possono creare un film superficiale che andrebbe a modificare le caratteristiche naturali del grès porcellanato).*

In presenza di macchie persistenti e difficili da togliere con la pulizia ordinaria, intervenire con impiego di detergenti più concentrati lasciando agire gli stessi per un adeguato intervallo di tempo e, successivamente, strofinare con adeguata intensità, fino a ricondurre le piastrelle all'aspetto originario. Al riguardo è opportuno segnalare che il grès è resistente a qualsiasi sostanza chimica, **eccezion fatta per l'acido fluoridrico che attacca tutti i prodotti ceramici e che, quindi, non deve mai essere utilizzato.** Per la pulizia di pavimenti in aree pubbliche si consiglia di intervenire dopo la chiusura dei locali, affinché il pavimento alla riapertura sia asciutto; in alternativa isolare il pavimento pulito fino alla sua completa asciugatura. Per i locali di maggiore estensione è opportuno disporre di macchine lavasciuga, per assicurare una perfetta pulizia e igienicità.

Il pavimento deve essere considerato pulito quando riacquista il suo aspetto originario!

CLEANING AND MAINTENANCE

A **Casalgrande Padana** flooring or wall covering, whether *natural*, *lapped*, *lucida* or *polished*, is synonym with beauty, strength and a long life. These surfaces are low maintenance and only need be cleaned as described below.

First clean

The purpose of first-time cleaning is to remove any trace of cement or plaster used to close the joints. The flooring/wall covering is normally cleaned once before use. This must be done after installation and before use. Proceed as follows:

1. Sweep the floor/covering to remove the coarser dirt.
2. Dampen the surface with water so as to soak the joints, thereby protecting them from the corrosive action of the acid detergent (descaling product).
3. Apply the detergent (see note A) in the concentration (water mixing ratio) indicated by the manufacturer using a manual or motorised brush. Avoid any contact between the acid detergent and the steel, aluminium, and natural marble components near the flooring/wall covering.
4. Leave it as long as needed depending on the condition of the floor, then rub any stubborn dirt away (such as mortar, plaster, etc. ...).
5. Rinse the flooring/covering with water and mop up the dirty water immediately (manually or with a washer/drier).

If the flooring/wall covering is cleaned for the first time after being used, it is important to use appropriate alkaline detergents (degreasing agents) before applying the acid detergent to remove any greasy or similar substance (see Routine Cleaning). If necessary, you can repeat the first-time cleaning operations described above.

Polished, lucida and lapped surfaces

A slight loss of shine after the first acid wash must be considered normal, as it is due to the removal of the abrasive residues used for processing the surface.

A) Here are a few detergents recommended for removing plaster residues

Cement plaster joints – acid detergents (descaling products):

Deterprimo Plus (Casalgrande Padana), Deterdek (Fila), Keranet (Mapei), Deltaplus (Kerakoll), Solvacid (Geal) or similar detergents (follow the manufacturer's instructions)

Epoxy plaster joints – alkaline detergents:

Fuga-Soap Eco (Kerakoll), Kerapoxy Cleaner (Mapei), Tile Cleaner (Faber), CR10 (Fila), Lithofin Resin-Ex (Lithofin), Eposolv (Geal) or similar detergents (follow the manufacturer's instructions)

Routine cleaning

For everyday cleaning, all you have to do is wash the flooring/wall covering with water and normal neutral detergents suitable for ceramic surfaces (for wall coverings use a neutral gel detergent gel).

*Make sure that the detergents do not contain waxy substances. The surface of **Casalgrande Padana** products are practically non-absorbent; therefore, the use of wax and/or silicone cleaners is not required. These should never be used, as they create a superficial film that changes the natural characteristics of porcelain stoneware.*

Should there be any stubborn stain that cannot be removed by routine cleaning, use a more concentrated detergent and leave it on for long enough, then rub harder until the tiles are back to their original condition. Note that porcelain stoneware is resistant to any chemical, **except hydrofluoric acid, which eats into any ceramic, so it must never be used.** Floors of public areas should be cleaned when the place is closed, so the floor will be dry when it reopens; otherwise, fence off the cleaned floor until perfectly dry. For larger places, use a washer/drier to ensure perfect cleanliness and hygiene.

The flooring is to be considered clean when it returns to its original appearance!

ENTRETIEN ET NETTOYAGE

Les revêtements de sol et de mur de **Casalgrande Padana**, qu'ils soient en version *naturelle*, *poncée*, *brillante* ou *polie*, sont synonymes de beauté, de solidité et de durabilité. Ils n'exigent aucune opération d'entretien particulière, il suffit de suivre les conseils d'entretien suivants :

Premier nettoyage

Son but est d'éliminer toute trace de ciment ou de mortier-colle après le jointoiement. Cette opération est généralement effectuée une seule fois avant d'utiliser le revêtement sol/mur, et il faut obligatoirement l'effectuer après la pose et avant toute utilisation du revêtement sol/mur.

Procéder de la manière suivante :

1. Balayer/épousseter le revêtement sol/mur en éliminant toutes traces d'impuretés.
2. Humidifier la surface avec de l'eau de manière à bien imprégner les joints afin qu'ils soient ainsi bien protégés de l'action corrosive du nettoyant acide (décalcifiant).
3. Respecter la concentration (quantité à diluer dans l'eau) indiquée par le fabricant pour l'utilisation du produit nettoyant, et appliquer le produit (voir note A) à l'aide d'une brosse manuelle ou motorisée. Veillez à ce que le nettoyant acide n'entre pas en contact d'éléments en acier et en aluminium, ou d'éléments en marbre naturel placés à proximité du revêtement sol/mur.
4. Pendant le temps d'action du produit, à établir en fonction de l'état du sol, frotter les taches les plus persistantes (et racler d'éventuels résidus de mortier, de mortier-colle, etc.).
5. Rincer le revêtement sol/mur avec de l'eau, puis éliminer immédiatement l'eau sale (à la main ou avec un appareil de nettoyage à aspiration d'eau).

Si le premier nettoyage est effectué après avoir utilisé le revêtement sol/mur, avant d'appliquer le nettoyant acide, il est conseillé d'éliminer toute éventuelle trace de substance grasse ou similaire en utilisant les nettoyants alcalins (dégraissants) prévus à cet effet (voir Nettoyage ordinaire). S'il y a lieu, répéter cette première opération de nettoyage.

Surfaces polies, brillantes et poncées

Après le premier lavage avec le nettoyant acide, une légère diminution de la brillance des sols polis doit être considérée normale, étant due à l'élimination des résidus abrasifs utilisés lors du traitement de surface effectué en usine.

A) Voici certains nettoyants conseillés pour éliminer les résidus de mortier-colle

Joints réalisés en mortier-ciment – nettoyants acides (décalcifiants) :

Deterprimo plus (Casalgrande Padana), Deterdek (Fila), Keranet (Mapei), Deltaplus (Kerakoll), Solvacid (Geal) ou produits similaires (suivre les instructions du fabricant du produit nettoyant)

Joints réalisés en mortier-époxy – nettoyants alcalins :

Fuga-Soap Eco (Kerakoll), Kerapoxy Cleaner (Mapei), Tile Cleaner (Faber), CR10 (Fila), Lithofin Resin-Ex (Lithofin), Eposolv (Geal) ou produits similaires (suivre les instructions du fabricant du produit nettoyant)

Nettoyage ordinaire

Pour le nettoyage quotidien, il suffit de laver le revêtement sol/mur avec de l'eau en y diluant des produits nettoyants adaptés aux surfaces en céramique (pour les murs, utiliser des produits nettoyants sous forme de gel).

S'assurer que les produits nettoyants ne contiennent pas de substances à base de cire ; la surface des produits Casalgrande Padana étant pratiquement non absorbante, il n'y a aucun besoin de passer ni cire ni autre produit similaire de protection à base de silicone ; bien au contraire, ces produits ne doivent jamais être utilisés (ils pourraient créer un film superficiel susceptible de modifier les caractéristiques naturelles du grès cérame).

Néanmoins, en cas de taches persistantes et difficiles à éliminer par un nettoyage ordinaire, utiliser un produit nettoyant plus puissant en le laissant agir pendant un temps adéquat, puis frotter énergiquement jusqu'à ce que le carrelage retrouve son aspect d'origine. Il est intéressant de signaler que le grès résiste aux substances chimiques, **à l'exception de l'acide fluorhydrique qui attaque tous les produits céramiques et qui ne doit donc jamais être utilisé.** Pour le nettoyage de lieux publics, il est conseillé d'effectuer l'entretien après la fermeture des locaux, afin que le sol soit bien sec avant la réouverture. En alternative, isoler le sol nettoyé jusqu'à ce qu'il soit complètement sec.

Pour le nettoyage des sols sur de grandes surfaces, il convient d'utiliser des autolaveuses, pour garantir une hygiène et un nettoyage parfaits.

Le sol doit être considéré comme propre lorsqu'il retrouve son aspect d'origine !

PFLEGE UND REINIGUNG

Ein Fußboden oder eine Wandverkleidung von **Casalgrande Padana** ist sowohl in der *natürlichen* wie auch *anpolierten*, *polierten* oder *geschliffenen* Ausführung Ausdruck von Schönheit, Widerstandsfähigkeit und Langlebigkeit. Die Instandhaltung solcher Beläge verlangt keine besonderen Pflegemaßnahmen, sondern lediglich die Beachtung der folgenden Reinigungsverfahren.

Erstreinigung

Sie dient dazu, nach der Verfüugung jegliche Spur von Zement oder Fugenmörtel zu entfernen. Normalerweise wird sie nur einmal vor der Verwendung des Fußbodens bzw. der Wandverkleidung durchgeführt und sollte nach der Verlegung und vor der Nutzung vorgenommen werden. Gehen Sie dazu folgendermaßen vor:

1. Den Fußboden/die Verkleidung fegen und den groben Schmutz entfernen.
2. Die Oberfläche mit Wasser befeuchten, um die Fugen zu imprägnieren und somit vor der ätzenden Wirkung des säurehaltigen Reinigungsmittels (Kalklöser) zu schützen.
3. Das Reinigungsprodukt (siehe Anmerkung A) in der vom Hersteller vorgegebenen Konzentration (Mischverhältnis mit Wasser) mit einer Handbürste oder einer motorbetriebenen Bürste auftragen. Den Kontakt des säurehaltigen Reinigungsmittels mit etwaigen Komponenten aus Stahl, Aluminium und Naturmarmor, die am Fußboden/an der Wandverkleidung angrenzen, vermeiden.
4. Während der Wirkzeit, die je nach Zustand des Fußbodens festzulegen ist, den hartnäckigsten Schmutz abreiben (und etwaige Mörtel- und Kittrückstände usw. abkratzen).
5. Den Fußboden/die Wandverkleidung mit Wasser abspülen und das Schmutzwasser sofort aufnehmen (von Hand oder mit einer Bodenreinigungsmaschine).

Wenn die Erstreinigung erst nach der Benutzung des Fußbodens/der Wandverkleidung erfolgt, müssen vor der Anwendung des säurehaltigen Reinigungsmittels etwaige Fette oder ähnliche Stoffe mit geeigneten Alkalireinigern (Fettlösern) entfernt werden (siehe Normale Reinigung).

Falls erforderlich, kann die Erstreinigung wiederholt werden.

Geschliffene, polierte und anpolierte Oberflächen

Ein leichter Glanzverlust bei geschliffenen Oberflächen infolge der ersten säurehaltigen Wäsche des Fußbodens ist als normal zu betrachten, da er auf die Entfernung der Rückstände der für die Oberflächenbearbeitung verwendeten Schleifmittel zurückzuführen ist.

A) Einige empfohlene Reinigungsmittel zur Entfernung von Mörtelresten

Verfüugung mit Zementfugenmörtel – säurehaltige Reinigungsmittel (Kalklöser):

Deterprimo plus (Casalgrande Padana), Deterdek (Fila), Keranet (Mapei), Deltaplus (Kerakoll), Solvacid (Geal) oder ähnliche Mittel (die Angaben des Reinigungsmittelherstellers beachten)

Verfüugung mit Epoxidfugenmörtel – alkalische Reinigungsmittel: Fuga-Soap Eco (Kerakoll), Kerapoxy Cleaner (Mapei), Tile Cleaner (Faber), CR10 (Fila), Lithofin Resin-Ex (Lithofin), Eposolv (Geal) oder ähnliche Mittel (die Angaben des Reinigungsmittelherstellers beachten)

Normale Reinigung

Für die Alltagsreinigung genügt es, den Fußboden/die Wandverkleidung mit Wasser und normalen Reinigungsmitteln für Keramikflächen zu reinigen (für Wandverkleidungen Gels verwenden).

Da die Oberflächen der Produkte von Casalgrande Padana praktisch nicht aufnahmefähig sind, müssen für ihren Schutz keine Wachse und/oder silikonhaltige Produkte aufgetragen werden. Ganz im Gegenteil sollten diese niemals verwendet werden (sie können einen Oberflächenfilm bilden, der die natürlichen Eigenschaften des Feinsteinzeugs verändert).

Bei beständigen und schwer entfernbaren Flecken, die sich nicht mit einer normalen Reinigung beseitigen lassen, können konzentriertere Reinigungsmittel verwendet werden; diese sollte man für eine angemessene Zeit einwirken lassen und dann angemessen kräftig abreiben, bis die Platten wieder ihr ursprüngliches Aussehen zurückerhalten. Wir weisen darauf hin, dass Steinzeug gegen alle chemischen Mittel beständig ist, **mit Ausnahme von Fluorwasserstoffsäure, die alle Keramikprodukte angreift und daher nicht verwendet werden darf.** In öffentlichen Bereichen sollte die Reinigung nach der Schließzeit vorgenommen werden, damit der Boden bei der Wiedereröffnung trocken ist; anderenfalls sollte der gereinigte Bereich bis zur kompletten Trocknung abgesperrt werden.

Für große Räumlichkeiten ist der Einsatz von Reinigungsmaschinen empfehlenswert, um eine perfekte Reinigung und Hygiene sicherzustellen.

Der Bodenbelag gilt als sauber, wenn er wieder sein ursprüngliches Aussehen hat!



© Copyright Casalgrande Padana

Casalgrande Padana si riserva il diritto di apportare al presente catalogo variazioni e/o correzioni sulla base dell'evoluzione tecnologica e della ricerca della ottimizzazione del prodotto. I colori e l'estetica dei prodotti sono quanto più possibile vicini a quelli reali, nei limiti dei processi di stampa.

Casalgrande Padana reserves the right to make changes and/or corrections to this catalogue based on the technological developments and product optimisation. The colour and appearance of the products as shown are as close as possible to the real thing, inside the limitations of the printing process.

Casalgrande Padana se réserve le droit d'apporter des modifications et/ou des corrections au présent catalogue, en fonction de l'évolution technologique et de la recherche en matière d'optimisation du produit. Les couleurs et l'apparence des produits sont aussi fidèles à la réalité que possible, dans les limites des processus d'impression.

Casalgrande Padana behält sich das Recht vor, auf Grundlage der technischen Entwicklung und der Erforschung der Produktoptimierung Änderungen und/oder Korrekturen an diesem Katalog vorzunehmen. Die Farben und das Aussehen der Produkte entsprechen den tatsächlichen Produkten, soweit dies im Rahmen der Druckprozesse möglich ist.

Questo catalogo è stampato su carta certificata FSC®.
This catalog is printed on FSC® certified paper.





CASALGRANDE
PADANA
Pave your way

Via Statale 467, n°73 - 42013 Casalgrande (RE) - Italia
Tel +39 0522 9901 - Fax +39 0522 996121
info@casalgrandepadana.it - www.casalgrandepadana.com

